

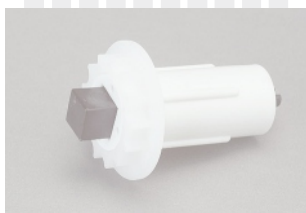

bamar.pl



---



# BAMAR 11

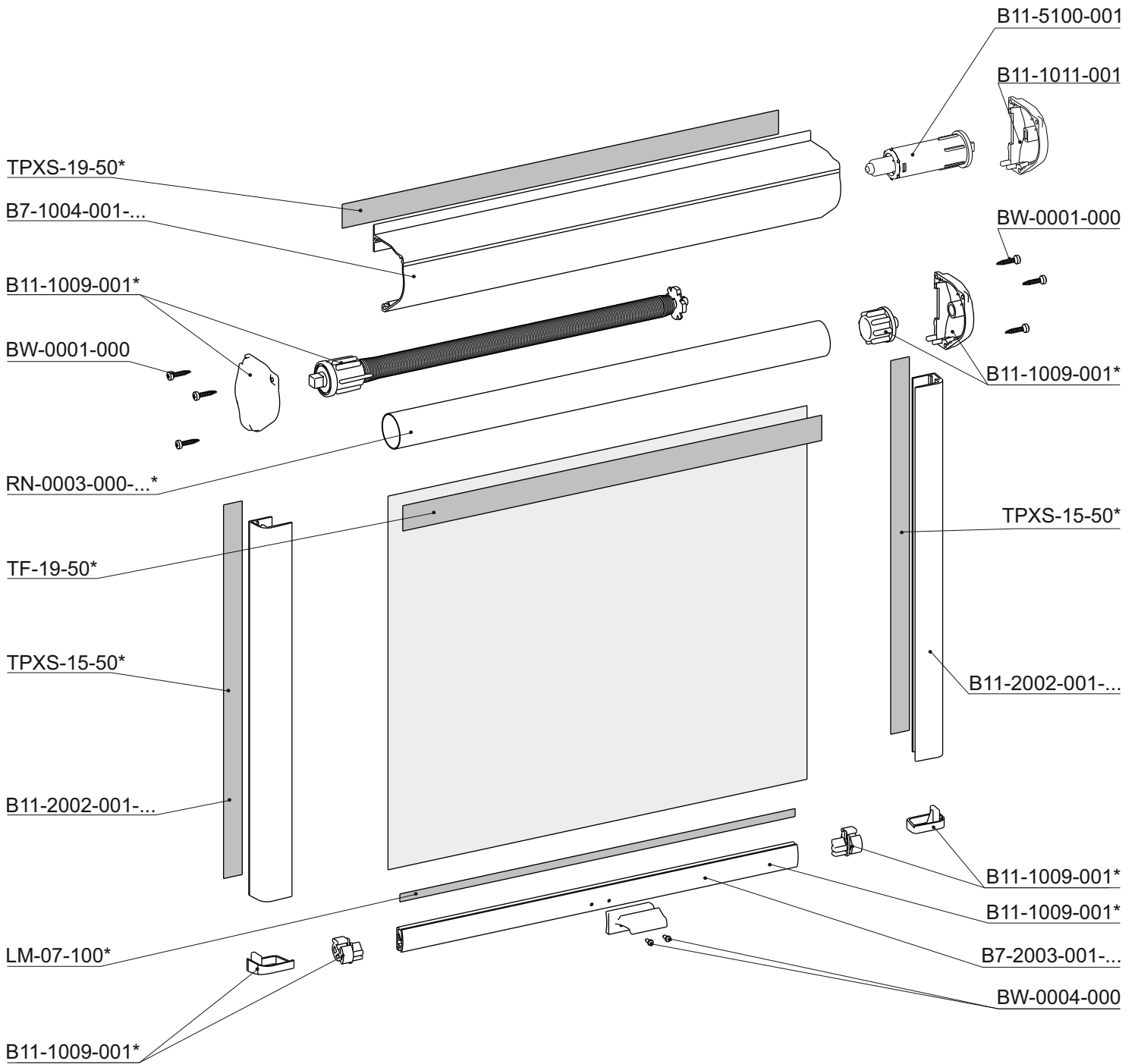



# B11



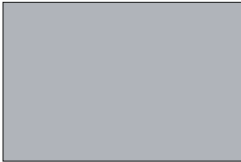

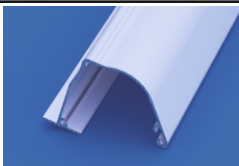
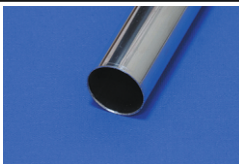
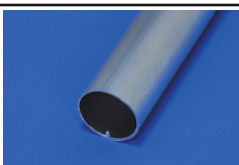
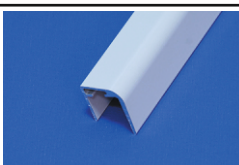
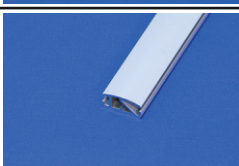

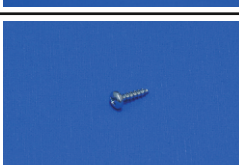
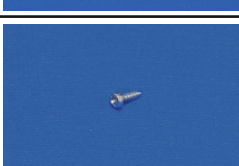
*	↻
RN-0003-000-...	RN-0007-000-...
B11-1009-001	B11-1109-001
TF-19-50	DW-19-50
TPXS-15-50	TPXS-15-50-003
LM-07-100	LM-06-100

# B11

Kod Code Code Код	Kolor	Colour	Farbe	Цвет	
001	biały	white	weiss	белый	
002	brązowy	brown	braun	коричневый	
003	antracyt	anthracite	anthrazit	антрацит	
111	srebrny	silver	silber	серебристый	

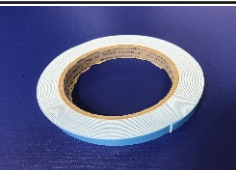
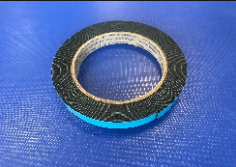
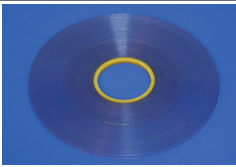
Kod Code Code Код	Nazwa Name Bezeichnung Название	Kolor Colour Farbe Цвет	Pakowanie Packing Packen Упаковка	
B7-1004-001	Kaseta aluminiowa B7 biała, 2.65m, 5,8m, 6m Aluminium cassette B7 white, 2.65m, 5,8m, 6m Aluminiumkassette B7 weiss, 2.65lm, 5,8lm, 6lm Кассета алюминиевая B7 белая, 2.65м, 5,8м, 6м	001, 002, 003, 111	46,4/48 mb/lm/lm/m	
RN-0003-000	Rura aluminiowa, 25,0 x 0,7; 2.65m, 3m, 6m Aluminium tube 25,0x0,7; 2.65m, 3m, 6m Aluminiumrohr 25,0 x 0,7; 2.65lm, 3lm, 6lm Труба алюминиевая 25,0 x 0,7; 2.65м, 3м, 6м	000	26,5/30/60 mb/lm/lm/m	
RN-0007-000	Rura aluminiowa 26,3 x 1,15, 5.8m Aluminium tube 26,3x1,15, 5.8m Aluminiumrohr 26,3 x 1,15, 5.8m Труба алюминиевая 26,3 x 1,15, 5.8m	000	58 mb/lm/lm/m	
B11-2002-001	Prowadnica zaokrąglona B11 biała; 6m Aluminium side guide round B11 white; 6m Aluminium Seitenführung B11 weiss; 6m Направляющая B11 алюминиевая белая; 6м	001, 002, 003, 111	120 mb/lm/lm/m	
B7-2003-001	Belka obciążająca aluminiowa biała, 2.65m, 5,8m Aluminium bottom bar white, 2.65m, 5,8m Aluminium Unterleiste, 2.65lm, 5,8lm Планка нижняя алюминиевая белая, 2.65м, 5,8м	001, 002, 003, 111	26,5/58 mb/lm/lm/m	
B11-1009-001	Komplet części B11, biały Spring mechanism B11, white Antrieb B11 weiss Механизм управления B11 белый	001, 002, 003, 111	25 kpl/set/kpl/ компл	
B11-1109-001	Komplet części B11 ze spowalniczem, biały Spring mechanism B11 with speed reducer, white Antrieb B11 mit Slowanlage, weiss Механизм B-11 с редуктором, белый	001, 002, 003, 111	25 kpl/set/kpl/ компл	
BW-0001-000	Blachowkręt 3,0x12 Screw 3,0x12 Schraube 3,0x12 Шуруп 3,0x12	000	1000 szt/pcs/st/шт	
BW-0004-000	Blachowkręt 2,2 x6,5 Screw 2,2x6,5 Schraube 2,2 x 6,5 Шуруп 2,2 x 6,5	000	2000 szt/pcs/st/шт	
B11-5100-001	Reduktor prędkości 25mm Speed reducer 25mm Geschwindigkeit Reduktor 25 mm Редуктор скорости 25мм	001	1 szt/pcs/st/шт	

Kod Code Code Код	Nazwa Name Bezeichnung Название	Kolor Colour Farbe Цвет	Pakowanie Packing Packen Упаковка	
<b>B11-1011-001</b>	Boczki B11 do spowalniaczy białe Cassette brackets for speed reducer, white B11 Slowmechanism Deckel, weiss Боковые крышки для редуктора	001, 002, 003, 111	1 kpl/set/kpl/ компл	
<b>DW-19-50</b>	Taśma dwustronna wzmocniona Strengthened double-sided tape Doppelseitiges verstärktes Klebeband Лента двухсторонняя укрепленная	9, 12, 15, 19, 25, 38	1 szt/pcs/st/шт	
<b>TPXS-15-50</b>	Taśma piankowa solwentowa Foam tape solvent Schaumklebeband Lösungsmittel Лента пенковая растворитель	9,12,15,19	1 szt/pcs/st/шт	
<b>TPXS-15-50-003</b>	Taśma piankowa solwentowa antracyt Foam tape solvent anthracite Lösungsmittel-Schaumklebeband Anthrazit лента для вспененного растворителя антрацит	9, 15, 19	1 szt/pcs/st/шт	
<b>LM-07-100</b>	Listwa mocująca z klejem Fastening belt with glue Befestigungsleiste mit Kleber Полоска для крепления с клеем	4, 6, 7, 8, 9, 16	1 szt/pcs/st/шт	
<b>TF-19-50</b>	Taśma dwustronna na flizelinie, Flizeline double-sides tape Doppelseitiges Klebeband, Лента двухсторонняя на флизелине	9, 12, 15, 19, 25	1 szt/pcs/st/шт	



**BAMAR-POL SP. Z O.O.**  
Graniczna 2  
45-587 Opole, Poland  
VAT no. 754-04-03-981

**PL OFFICE**  
Dworcowa 20  
46-024 Jełowa, Poland  
tel.: +48 774 270 110  
handlowy@bamar.pl

**EXPORT OFFICE**  
Dworcowa 20  
46-024 Jełowa, Poland  
tel.: +48 774 270 010  
export@bamar.pl