

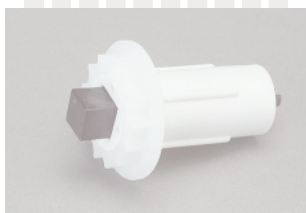

bamar.pl



BAMAR 18

B18

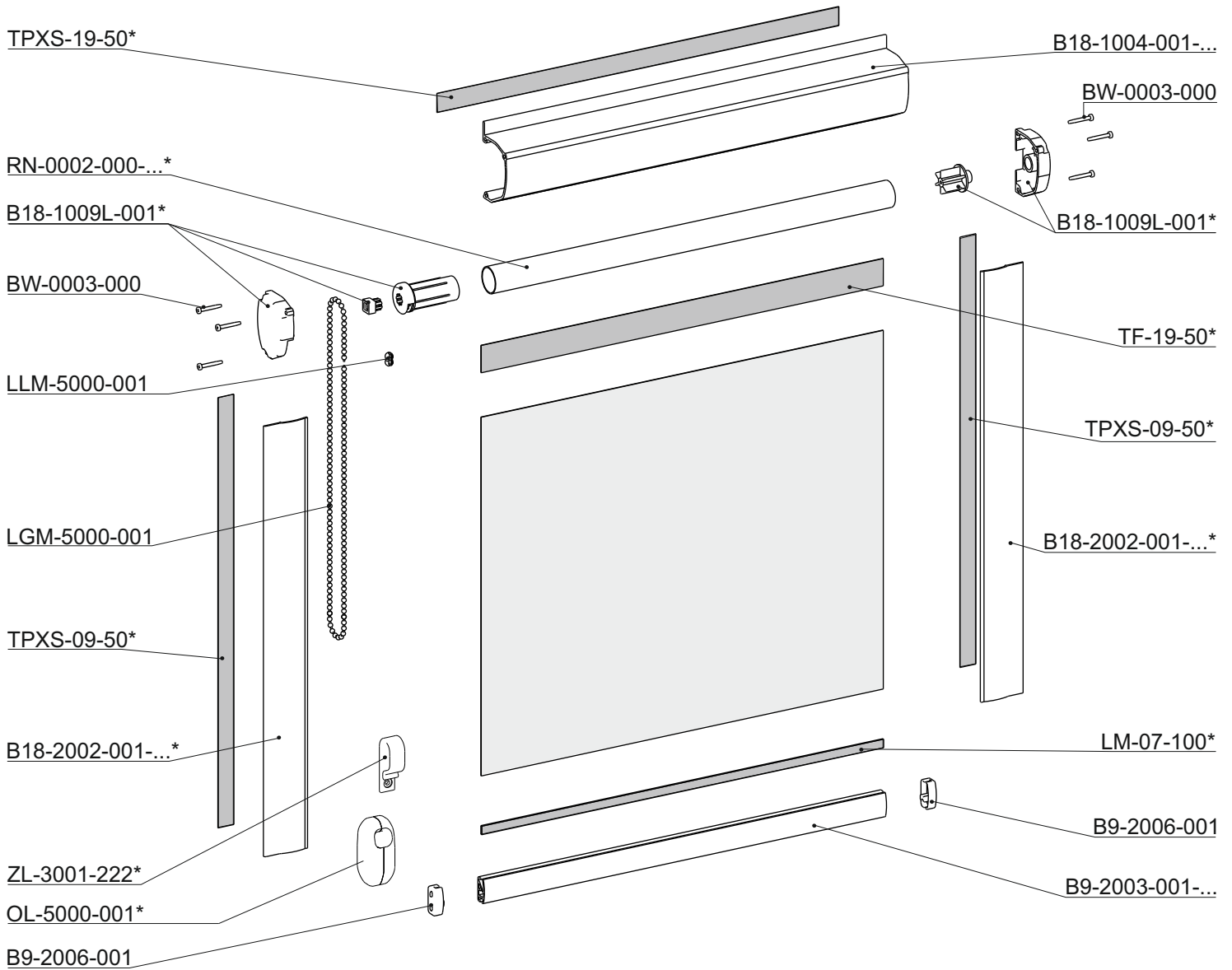

*







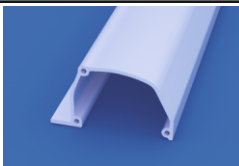
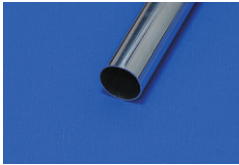
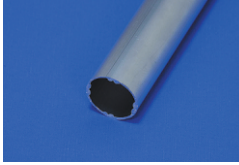

B18-2002-001-...
 RN-0002-000-...
 B18-1009L-001
 ZL-3001-222
 OL-5000-001
 TF-19-50
 TPX-09-50
 TPX-19-50
 LM-07-100

B18-2001-001-...
 RN-0006-000-...
 B18-1009P-001
 ZL-3000-222
 OL-1000-001
 DW-19-50
 TPX-09-50-003
 TPX-19-50-003
 LM-06-100

B18

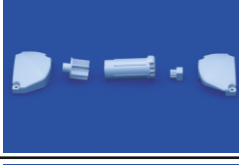
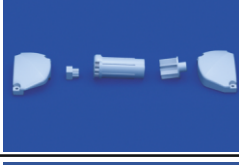
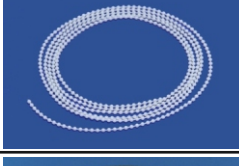
Kod Code Code Код	Kolor	Colour	Farbe	Цвет	
001	biały	white	weiss	белый	

Kod Code Code Код	Nazwa Name Bezeichnung Название	Kolor Colour Farbe Цвет	Pakowanie Packing Packen Упаковка	
B18-1004-001	Kaseta PCV B18 biała, 2,65m, 4m Rounded PVC cassette B18 white 2,65m, 4m PVC Kasette B18 weiss, 2,65 m, 4m Кассета ПВХ B18 белая, 2,65м, 4м	001	26,5/40 mb/lm/lm/m	
RN-0002-000	Rura aluminiowa 18,0 x 0,65; 2.65m, 3m, 6m Aluminium tube 18,0x0,65; 2.65m, 3m, 6m Aluminiumrohr 18,0 x 0,65; 2.65lm, 3m, 6m Труба алюминиевая 18,0 x 0,65; 2.65м, 3м, 6м	000	26,5/30/60 mb/lm/lm/m	
RN-0006-000	Rura aluminiowa ożebrowana 19,0 x 1,1, 5.8m Aluminium tube strengthened 19,0x1,1, 5.8m Aluminiumrippenrohr 19,0 x 1,1, 5.8m Труба алюминиевая укрепленная 19,0 x 1,1, 5.8м	000	58 mb/lm/lm/m	
B18-2001-001	Prowadnica B18 szeroka, biała, 2,65m PVC side guide B18 wide white 2,65m PVC Seitenführung B18 breit, weiss 2,65m Направляющая ПВХ B18 широкая, белая, 2,65м	001	132,5 mb/lm/lm/m	
B18-2002-001	Prowadnica B18 wąska, biała, 2.65m PVC side guide B18 narrow white 2.65m PVC Seitenführung B18 schmal, weiss, 2.65m Направляющая ПВХ B18 узкая белая, 2.65м	001	132,5 mb/lm/lm/m	
B9-2003-001	Belka obciążająca PCV, 2.65m PVC bottom bar, 2,65m PVC Unterleiste, 18 mm, 2,65m Планка нижняя ПВХ белая, 2,65м	001	53 mb/lm/lm/m	
B18-1009P-001	Komplet części B18 prawy, biały Chain mechanism B18 right white Antrieb B18, rechts, weiss Механизм управления B18 правый, белый	001	25 kpl/set/kpl/ компл	
B18-1009L-001	Komplet części B18 lewy, biały Chain mechanism B18 left white Antrieb B18, links, weiss Механизм управления B18 левый, белый	001	25 kpl/set/kpl/ компл	
LGM-5000-001	Łańcuszek kulkowy mini, biały Ball chain mini white Mini-Perlenkette, weiss Цепочка шариковая мини, белая	001	250 mb/lm/lm/m	
LGM-1000-011-P	Łańcuszek kulkowy mini transparentny biały Ball chain mini transparent white Mini-Perlenkette, Transparent weiss Цепочка шариковая мини, прозрачная белая	011	250 mb/lm/lm/m	

Kod Code Code Код	Nazwa Name Bezeichnung Название	Kolor Colour Farbe Цвет	Pakowanie Packing Packen Упаковка	
LLM-5000-001	Łącznik łańcuszka mini, biały Connection clip mini white Mini-Kogelkettenverbinder, weiss Соединитель цепочки мини, белый	001	100 szt/pcs/st/шт	
ZL-3001-222	Uchwyt zabezpieczający łańcuszka mały, bezbarwny Safety handle for chain, transparent Sicherheitsgriff für die Kette, farblos Малый фиксатор цепочки, прозрачный	222	100 szt/pcs/st/шт	
ZL-3000-222	Uchwyt zabezpieczający łańcuszka, bezbarwny Safety handle for chain, transparent Sicherheitsgriff für die Kette, farblos Фиксатор цепочки, прозрачный	222	100 szt/pcs/st/шт	
OL-1000-001	Obciążnik łańcuszka, biały Ball chain weight, white Kettenbeschwerer, weiss Грузик цепочки, белый	001	200 szt/pcs/st/шт	
OL-5000-001	Obciążnik łańcuszka, biały Ball chain weight, white Kettenbeschwerer, weiss Грузик цепочки, белый	001	100 szt/pcs/st/шт	
OL-5010-111	Balast obciążnika łańcuszka Ballast chain weight Ballast für Kettenbeschwerer Балласт грузика цепочки	111	100 szt/pcs/st/шт	
B38-1100-001	Wpięcie łańcuszka mini, białe Chain handle mini white Ketten mit Abstanhalter mini, weiss Крепитель цепочки мини, белый	001	100 szt/pcs/st/шт	
B9-2006-001	Zaślepka belki obciążającej, biała End cap, white Endleiste Blendestopfen, weiss Заглушка нижней планки, белая	001	125 kpl/set/kpl/ компл	
BW-0003-000	Blachowkręt 2,2 x16 Screw 2,2x16 Schraube 2,2 x 16 Шуруп 2,2 x 16	000	2000 szt/pcs/st/шт	

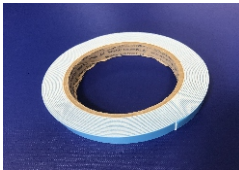
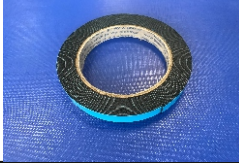
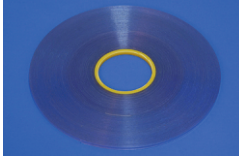
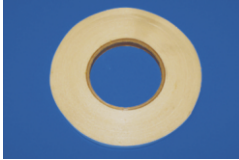
Kod Code Code Код	Nazwa Name Bezeichnung Название	Szerokość Width Breite Ширина	Pakowanie Packing Packen Упаковка	
DW-19-50	Taśma dwustronna wzmocniona Strengthened double-sided tape Doppelseitiges verstärktes Klebeband Лента двухсторонняя укрепленная	9, 12, 15, 19, 25, 38	1 szt/pcs/st/шт	
TPXS-19-50	Taśma piankowa solwentowa Foam tape solvent Schaumklebeband Lösungsmittel Лента пенковая растворитель	9,12,15,19	1 szt/pcs/st/шт	
TPXS-19-50-003	Taśma piankowa solwentowa antracyt Foam tape solvent anthracite Lösungsmittel-Schaumklebeband Anthrazit лента для вспененного растворителя антрацит	9, 15, 19	1 szt/pcs/st/шт	
LM-07-100	Listwa mocująca z klejem Fastening belt with glue Befestigungsleiste mit Kleber Полоска для крепления с клеем	4, 6, 7, 8, 9, 16	1 szt/pcs/st/шт	
TF-19-50	Taśma dwustronna na flizelinie, Flizeline double-sides tape Doppelseitiges Klebeband, Лента двухсторонняя на флизелине	9, 12, 15, 19, 25	1 szt/pcs/st/шт	



BAMAR-POL SP. Z O.O.
Graniczna 2
45-587 Opole, Poland
VAT no. 754-04-03-981

PL OFFICE
Dworcowa 20
46-024 Jełowa, Poland
tel.: +48 774 270 110
handlowy@bamar.pl

EXPORT OFFICE
Dworcowa 20
46-024 Jełowa, Poland
tel.: +48 774 270 010
export@bamar.pl