

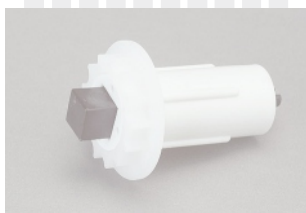

bamar.pl



BAMAR 19

B19

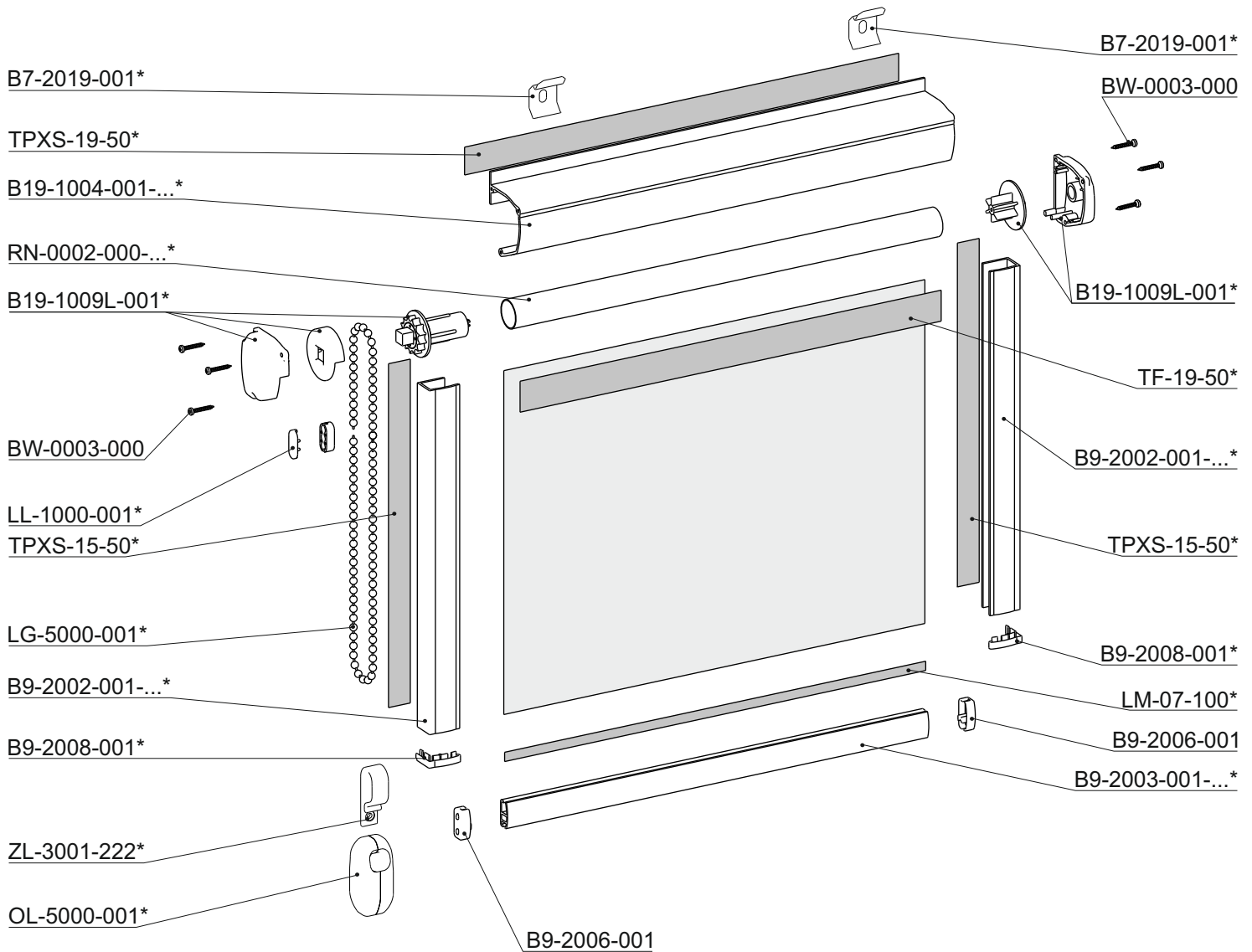



B19-1004-001-...
 B9-2002-001-...
 B9-2003-001-...
 RN-0002-000-...
 B19-1009L-001
 LG-5000-001 + LL-1000-001
 LL-1000-001
 B9-2006-001
 B9-2008-001
 B7-2019-001
 ZL-3001-222
 OL-5000-001
 TF-19-50
 TPXS-15-50
 TPXS-19-50
 LM-07-100

B19-1014-001-...
 B9-2001-001-..., B19-2001-001-..., B19-2002-001-... , B9-2012-001
 B7-2003-001-...
 RN-0006-000-...
 B19-1009P-001
 LG-5000-001-P+LL-1000-222, LP-5000-001- ..., LP-5000-001- ... -P
 LL-5000-001
 B7-2007-001
 B9-2018-001
 B7-2009-001
 ZL-3000-222
 OL-1000-001
 DW-19-50
 TPXS-15-50-003
 TPXS-19-50-003
 LM-06-100

B19 D&N

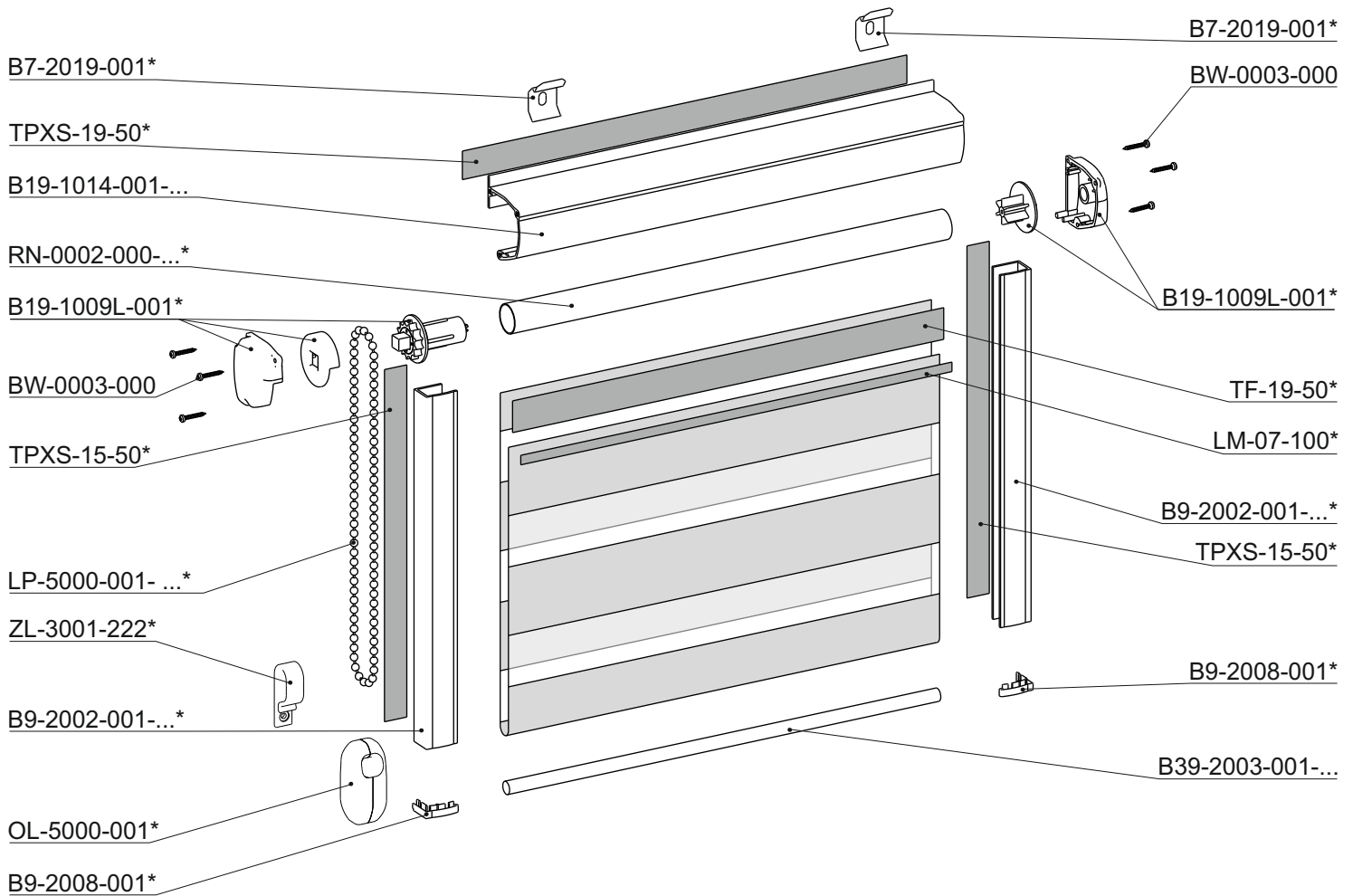

B9-2002-001
 RN-0002-000-...
 B19-1009L-001
 LP-5000-001- ...
 B9-2008-001
 B7-2019-001
 ZL-3001-222
 OL-5000-001
 TF-19-50
 TPXS-15-50
 TPXS-19-50
 LM-07-100



B9-2001-001-..., B19-2001-001-..., B19-2002-001-... , B9-2012-001
 RN-0006-000-...
 B19-1009P-001
 LP-5000-001- ... , LP-5000-001- ... -P
 B9-2018-001
 B7-2009-001
 ZL-3000-222
 OL-1000-001
 DW-19-50
 TPXS-15-50-003
 TPXS-19-50-003
 LM-06-100

B19 D&N

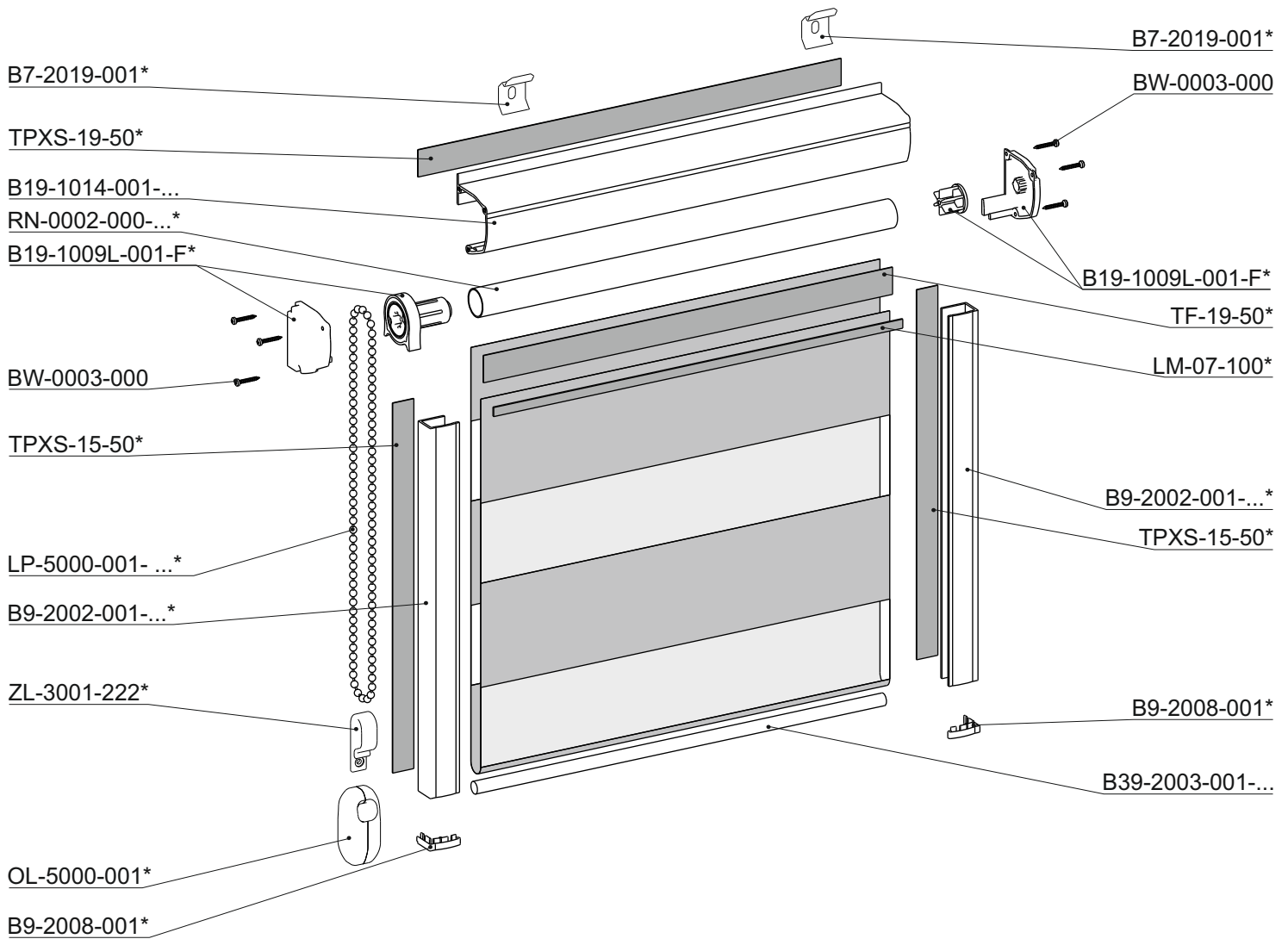









*



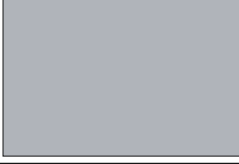







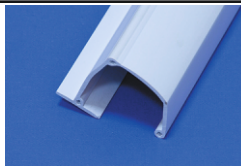
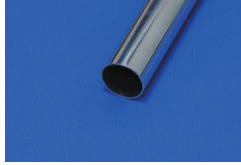
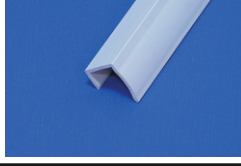

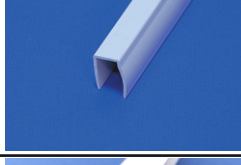
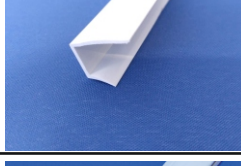



B9-2002-001
 RN-0002-000-...
 B19-1009L-001-F
 LP-5000-001- ...
 B9-2008-001
 B7-2019-001
 ZL-3001-222
 OL-5000-001
 TF-19-50
 TPXS-15-50
 TPXS-19-50
 LM-07-100



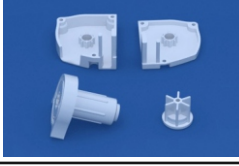

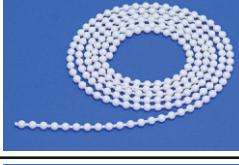



B9-2001-001-..., B19-2001-001-..., B19-2002-001-... , B9-2012-001
 RN-0006-000-...
 B19-1009P-001-F
 LP-5000-001- ... , LP-5000-001- ... -P
 B9-2018-001
 B7-2009-001
 ZL-3000-222
 OL-1000-001
 DW-19-50
 TPXS-15-50-003
 TPXS-19-50-003
 LM-06-100



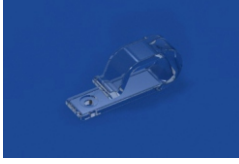
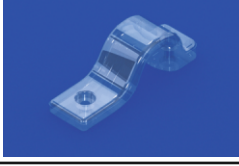

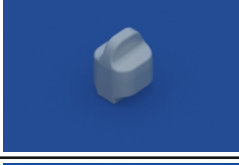
B19

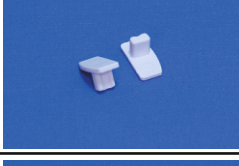
Kod Code Code Код	Kolor	Colour	Farbe	Цвет	
001	biały	white	weiss	белый	
003	antracyt	anthracite	anthrazit	антрацит	
011	brązowy	brown	braun	коричневый	
111	srebrny	silver	silber	серебристый	
308 408	dąb złoty	gold oak	eiche-gold	золотой дуб	
309 409	jasny dąb	light oak	eiche-hell	светлый дуб	
310 410	orzech	nut brown	nuss	орех	
311 411	mahoń	mahogany	mahagoni	махагон	
312 412	wisnia	cherry red	kirsche	вишня	
313 413	orzech wenge	wenge nut	nuss-wenge	венге	

Kod Code Code Код	Nazwa Name Bezeichnung Название	Kolor Colour Farbe Цвет	Pakowanie Packing Packen Упаковка	
B19-1004-001	Kaseta PCV B19 biała, 2,65m/5,8m/6m PVC cassette B19 white, 2,65m/5,8m/6m PVC Kasette B19 weiss, 2,65m/5,8m/6m Кассета ПВХ B19 белая, 2,65м/5,8м/6м	001, 003, 011, 408, 409, 410, 411, 412, 413	26,5/34,8/36 mb/lm/lm/m	
B19-1014-001	Kaseta PCV B19 D&N biała, 2,65m/6m PVC cassette B19 D&N white, 2,65m/6m PVC Kasette B19 D&N weiss, 2,65m/6m Кассета ПВХ B19 D&N белая, 2,65м/6м	001	26,5/36 mb/lm/lm/m	
RN-0002-000	Rura aluminiowa 18,0 x 0,65; 2,65m, 3m, 6m Aluminium tube 18,0x0,65; 2,65m, 3m, 6m Aluminiumrohr 18,0 x 0,65; 2,65lm, 3m, 6m Труба алюминиевая 18,0 x 0,65; 2,65м, 3м, 6м	000	26,5/30/60 mb/lm/lm/m	
RN-0006-000	Rura aluminiowa ożebrowana 19,0 x 1,1, 5,8m Aluminium tube strengthened 19,0x1,1, 5,8m Aluminiumrippenrohr 19,0 x 1,1, 5,8m Труба алюминиевая укрепленная 19,0 x 1,1, 5,8м	000	58 mb/lm/lm/m	
B9-2001-001	Prowadnica B9 9mm, dł. 2,65m; 6m PVC side guide B9 9 mm, 2,65m; 6m PVC Seitenführung B9 9 mm, 2,65m; 6m Направляющая B9 ПВХ 9мм, 2,65м; 6м	001, 003, 011, 408, 409, 410, 411, 412, 413	53/106/120/240 mb/lm/lm/m	
B9-2002-001	Prowadnica B9 18mm, 2,65m; 6m PVC side guide B9 18 mm, 2,65m; 6m PVC Seitenführung B9 18 mm, 2,65m; 6m Направляющая B9 ПВХ 18мм, 2,65м; 6м	001, 003, 011, 111, 408, 409, 410, 411, 412, 413	53/106/120/240 mb/lm/lm/m	
B19-2001-001	Prowadnica B19 mini, 9mm, 2,65m Mini PVC Sideguide B19, 9mm, 2,65m PVC Seiteführung B19 mini, 9mm, 2,65m Направляющая B19 ПВХ, 9мм, 2,65м	001	106 mb/lm/lm/m	
B19-2002-001	Prowadnica B19 mini, 18mm, 2,65m; 6m Mini PVC side guide B19, 18mm, 2,65m; 6m PVC Seiteführung B19 mini, 18mm, 2,65m; 6m Направляющая B19 ПВХ, 18мм, 2,65м; 6м	001	106/240 mb/lm/lm/m	
B9-2012-001	Prowadnica B9 z zaokrągloną stopką 2,65m PVC side guide B9 with rounded base 2,65m PVC Seitenführung B9 mit abgerundetem Fuß 2,65m Боковая направляющая из ПВХ B9 с закругленной ножкой 2,65 м	001	106 mb/lm/lm/m	
B9-2003-001	Belka obciążająca PCV biała, 2,65m PVC bottom bar, 2,65m PVC Unterleiste, 2,65m Планка нижняя ПВХ белая, 2,65м	001, 003, 011, 111, 408, 409, 410, 411, 412, 413	53 mb/lm/lm/m	

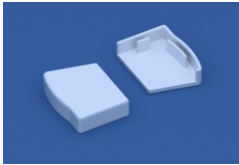
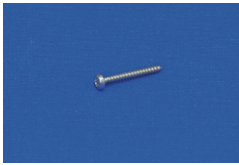
Kod Code Code Код	Nazwa Name Bezeichnung Название	Kolor Colour Farbe Цвет	Pakowanie Packing Packen Упаковка	
B7-2003-001	Belka obciążająca aluminiowa biała, 2.65m, 5,8m, 6m Aluminium bottom bar white, 2.65m, 5,8m, 6m Aluminium Unterleiste, 2.65lm, 5,8lm, 6lm Планка нижняя алюминиевая белая, 2.65м, 5,8м, 6м	001, 002, 003, 111, 308, 309, 310, 311, 312, 313	24/26,5/58/ 60/79,5/180 mb/lm/lm/m	
B39-2003-001	Pręt obciążający, biały, 2.65m Alu Tiltrod weight white, 2.65m Alu-Beschwerdestab- Weiss, 2.65m Прут-утяжелитель алюминиевый, белый, 2.65м	001, 002, 003, 111	26,5 mb/lm/lm/m	
B19-1009L-001	Komplet części B19 lewy Chain mechanism B19 left Antrieb B19 links Механизм управления B19 левый	001, 003, 011, 111, 308, 309, 310, 311, 312, 313	25 kpl/set/kpl/ компл	
B19-1009P-001	Komplet części B19 prawy Chain mechanism B19, right Antrieb B19 rechts Механизм управления B19 правый	001, 003, 011, 111, 308, 309, 310, 311, 312, 313	25 kpl/set/kpl/ компл	
B19-1009L-001-F	Komplet części B19 lewy płaski, biały Chain mechanism B19 flat left, white Antrieb B19 flach links, weiss Механизм управления B19 плоский левый белый	001, 003, 011, 111	25 kpl/set/kpl/ компл	
B19-1009P-001-F	Komplet części B19 prawy płaski, biały Chain mechanism B19 flat right, white Antrieb B19 flach rechts, weiss Механизм управления B19 плоский правый белый	001, 003, 011, 111	25 kpl/set/kpl/ компл	
LG-5000-001	Łańcuszek kulkowy Ø4,5mm, biały Ball chain Ø4,5mm, white Perlenkette Ø4,5mm, weiss Цепочка шариковая Ø4,5mm, прозрачная	001, 003, 011, 111, 408, 411	250 mb/lm/lm/m	
LG-5000-001-P	Łańcuszek kulkowy Ø4,45mm, przezroczysty Ball chain Ø4,45mm transparent Perlenkette Ø4,45 mm, transparent Цепочка шариковая Ø4,45mm, прозрачная	001, 003, 011, 111, 408, 411	250 mb/lm/lm/m	
LP-5000-001-...	Łańcuszek pętla 1; 1.5; 2; 2.5; 3; 3.5; 4m Chain loop 1; 1.5; 2; 2.5; 3; 3.5; 4m Endlosekette 1; 1.5; 2; 2.5; 3; 3.5; 4lm Цепочка-петля, 1; 1.5; 2; 2.5; 3; 3.5; 4м	001, 003, 011, 111, 408, 411	10 szt/pcs/st/шт	
LP-5000-001- ... -P	Łańcuszek pętla 1; 1.5; ;2; 2.5; 3; 3.5; 4m transparentny Chain loop 1; 1.5; 2; 2.5; 3; 3.5; 4m transparent Endlosekette 1; 1.5; 2; 2.5; 3; 3.5; 4m Transparent Цепочка-петля, 1; 1.5; 2; 2.5; 3; 3.5; 4м прозрачная	001, 003, 011, 111, 408, 411	10 szt/pcs/st/шт	

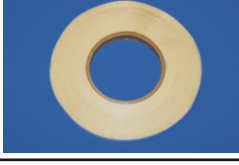
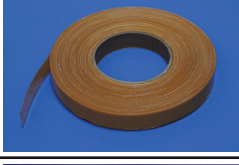
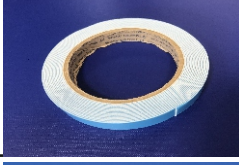
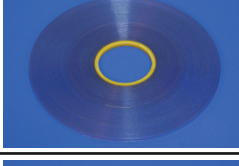
Kod Code Code Код	Nazwa Name Bezeichnung Название	Kolor Colour Farbe Цвет	Pakowanie Packing Packen Упаковка	
LL-1000-001	Łącznik łańcuszka, biały Connection clip, white Kugelhetteverbinder, weiss Соединитель цепочки, белый	001, 003, 011, 222, 308	100 szt/pcs/st/шт	
LL-5000-001	Łącznik łańcuszka, biały Connection clip, white Kugelhetteverbinder, weiss Соединитель цепочки, белый	001	100 szt/pcs/st/шт	
UL-1000-001	Uchwyt łańcuszka, biały Chain handle, white Kettengriff, weiss Крепитель цепочки, белый	001, 011, 111	125 szt/pcs/st/шт	
ZL-3001-222	Uchwyt zabezpieczający łańcuszka mały, bezbarwny Safety handle for chain, transparent Sicherheitsgriff für die Kette, farblos Малый фиксатор цепочки, прозрачный	222	100 szt/pcs/st/шт	
ZL-3000-222	Uchwyt zabezpieczający łańcuszka, bezbarwny Safety handle for chain, transparent Sicherheitsgriff für die Kette, farblos Фиксатор цепочки, прозрачный	222	100 szt/pcs/st/шт	
OL-5000-001	Obciążnik łańcuszka, biały Ball chain weight, white Kettenbeschwerer, weiss Грузик цепочки, белый	001, 003, 011, 111 408	100 szt/pcs/st/шт	
OL-5010-111	Balast obciążnika łańcuszka Ballast chain weight Ballast für Kettenbeschwerer Балласт грузика цепочки	111	100 szt/pcs/st/шт	
OL-1000-001	Obciążnik łańcuszka, biały Ball chain weight, white Kettenbeschwerer, weiss Грузик цепочки, белый	001, 003, 011, 111	200 szt/pcs/st/шт	
B7-2007-001	Zaślepka belki obciążającej płaska, biała End cap flat, white Endleiste Blendestopfen, weiss Заглушка нижней планки, белая	001, 002, 003, 111	125 kpl/set/kpl/ компл	
B9-2006-001	Zaślepka belki B9, biała End cap B9, white Endleiste Blendestopfen B9, weiss Заглушка нижней планки B9, белая	001, 003, 011, 111	125 kpl/set/kpl/ компл	

Kod Code Code Код	Nazwa Name Bezeichnung Название	Kolor Colour Farbe Цвет	Pakowanie Packing Packen Упаковка	
B9-2008-001	Zaślepka prowadnicy B9, biała Side guide end cap, white Endkappe für Seitenführung, weiss Заглушка направляющей, белая	001, 003, 011, 111, 308, 310, 311, 312	125 kpl/set/kpl/ компл	
B9-2018-001	Zaślepka prowadnicy B9 pełna, biała End cap for side guide B9, white Endkappe für Seitenführung, weiss Заглушка направляющей B9, белая	001, 003, 011, 111, 308, 309, 310, 311, 312, 313	125 kpl/set/kpl/ компл	
BW-0003-000	Blachowkręć 2,2 x16 Screw 2,2x16 Schraube 2,2 x 16 Шуруп 2,2 x 16	000, 010, 502	2000 szt/pcs/st/шт	
B7-2009-001	Klip kasety B7 Biały Cassette clip B7 white Montage Clip B7 weiss Клип кассеты B7 белый	001, 002	100 szt/pcs/st/шт	
B7-2019-001	Klip naścienny kasety B7, biały Wall clip for cassette B7 white Montage-Clip B-7 Weiss Клип настенный кассеты B7	001, 002	100 szt/pcs/st/шт	
TF-15-50	Taśma dwustronna na flizelinie, Flizeline double-sides tape Doppelseitiges Klebeband, Лента двухсторонняя на флизелине	9, 12, 15, 19, 25	1 szt/pcs/st/шт	
DW-19-50	Taśma dwustronna wzmocniona Strengthened double-sided tape Doppelseitiges verstärktes Klebeband Лента двухсторонняя укрепленная	9, 12, 15, 19, 25, 38	1 szt/pcs/st/шт	
TPXS-19-50-003	Taśma piankowa solwentowa antracyt Foam tape solvent anthracite Lösungsmittel-Schaumklebeband Anthrazit лента для вспененного растворителя антрацит	9, 15, 19	1 szt/pcs/st/шт	
LM-07-100	Listwa mocująca z klejem Fastening belt with glue Befestigungsleiste mit Kleber Полоска для крепления с клеем	4, 6, 7, 8, 9, 16	1 szt/pcs/st/шт	
LM-07-100	Listwa mocująca z klejem Fastening belt with glue Befestigungsleiste mit Kleber Полоска для крепления с клеем	4, 6, 7, 8, 9, 16	1 szt/pcs/st/шт	



BAMAR-POL SP. Z O.O.
Graniczna 2
45-587 Opole, Poland
VAT no. 754-04-03-981

PL OFFICE
Dworcowa 20
46-024 Jełowa, Poland
tel.: +48 774 270 110
handlowy@bamar.pl

EXPORT OFFICE
Dworcowa 20
46-024 Jełowa, Poland
tel.: +48 774 270 010
export@bamar.pl