

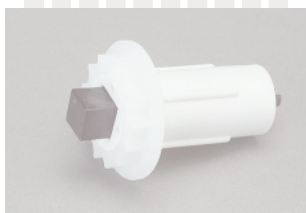

bamar.pl



BAMAR 26

B26

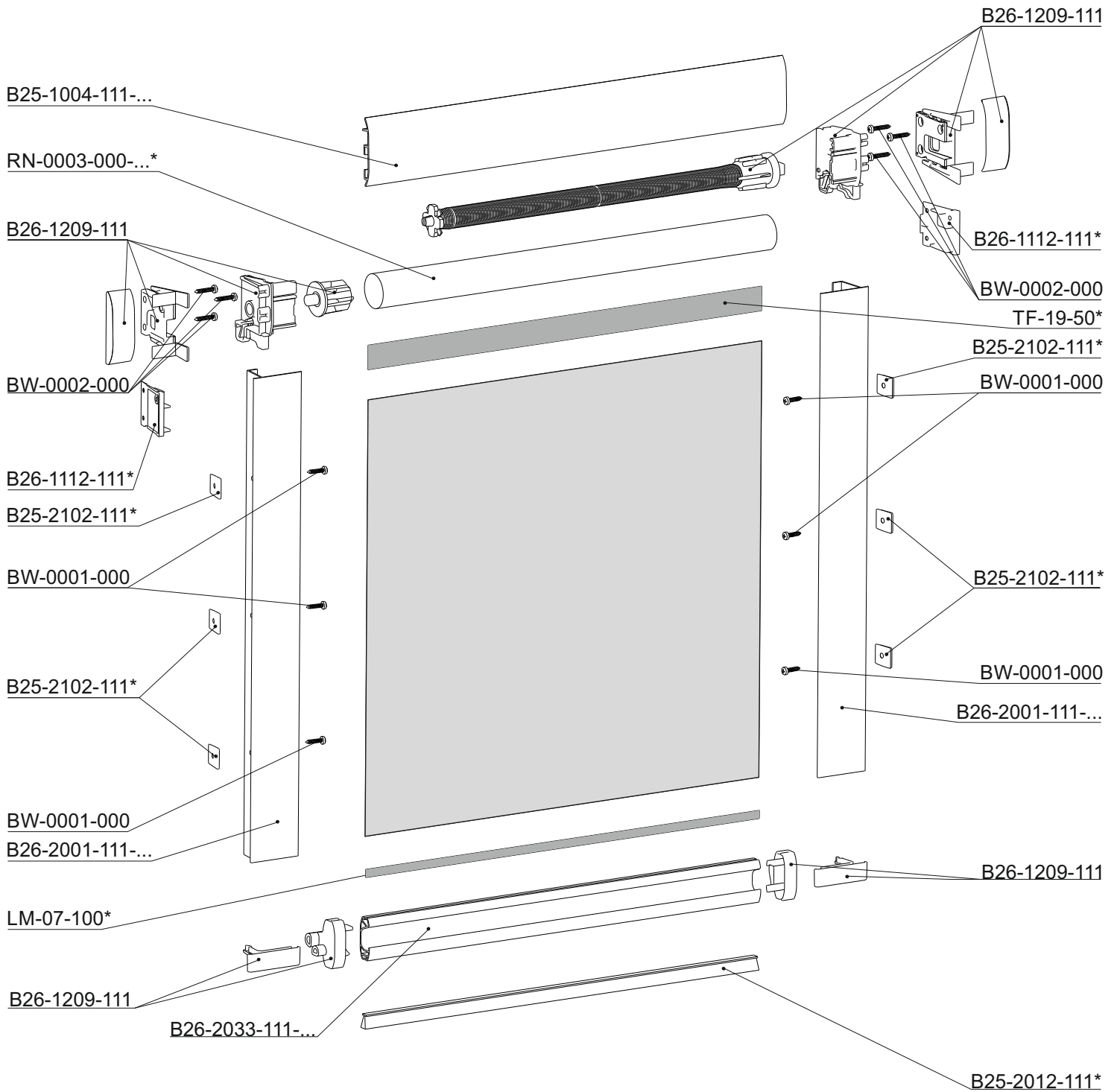



*	↻
RN-0003-000-...	RN-0007-000-...
B26-1112-111	B26-1190-111, B26-1110-111
B25-2102-111	B25-2103-001
B25-2012-111	B25-2011-111
TF-19-50	DW-19-50
LM-07-100	LM-06-100

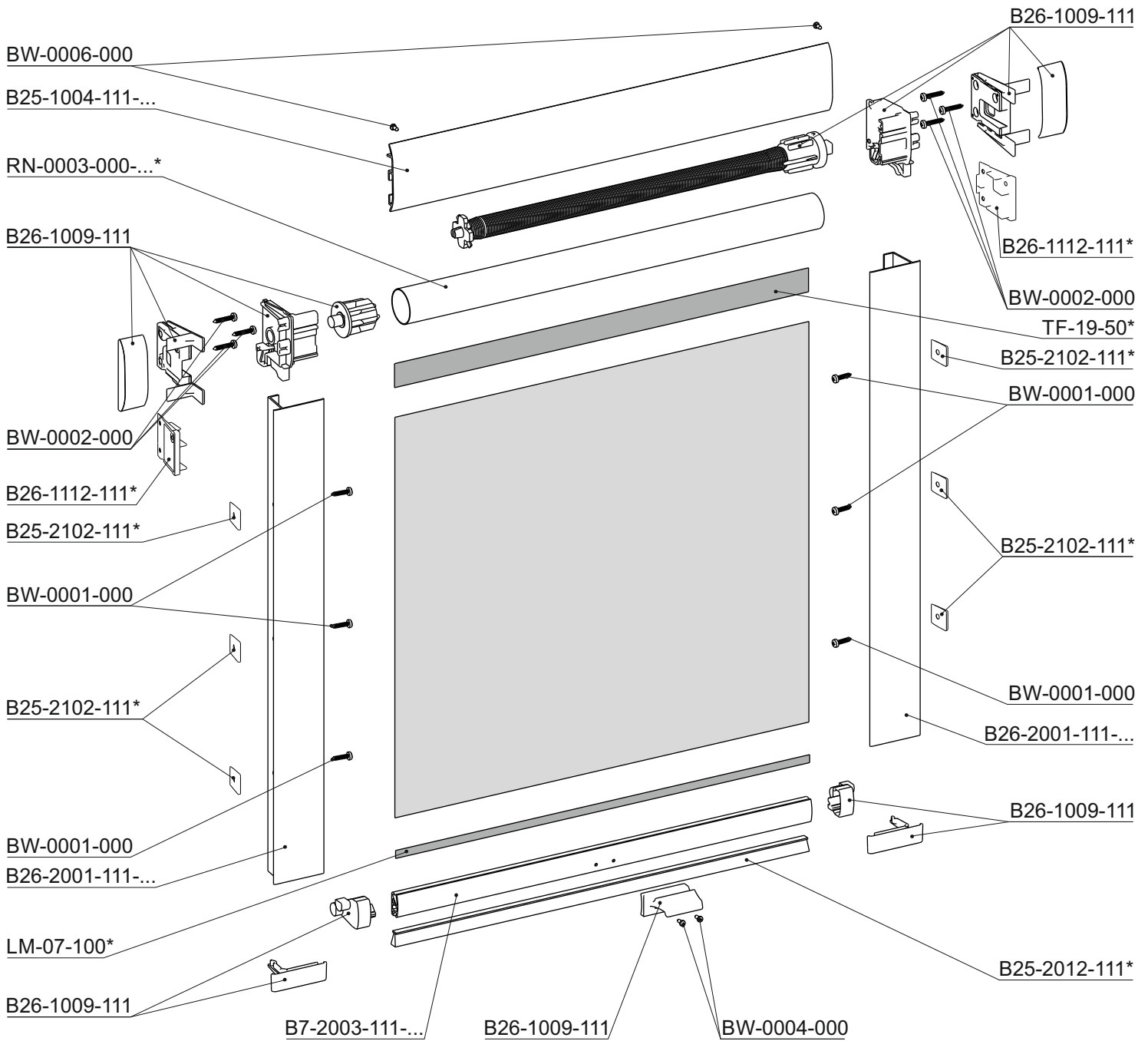





B26



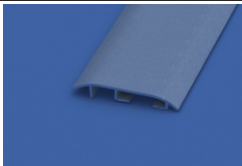
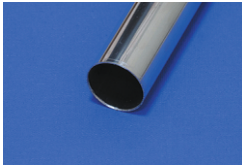
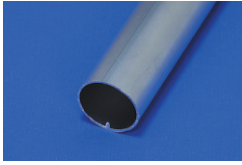

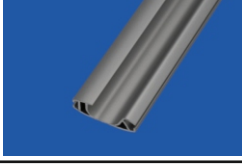
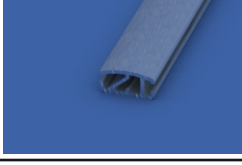
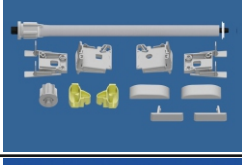



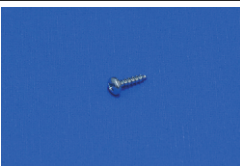

*	↻
RN-0003-000-...	RN-0007-000-...
B26-1112-111	B26-1190-111, B26-1110-111
B25-2102-111	B25-2103-001
B25-2012-111	B25-2011-111
TF-19-50	DW-19-50
LM-07-100	LM-06-100

B26

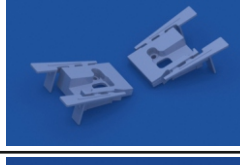
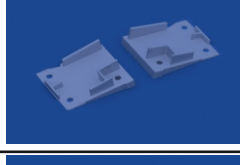
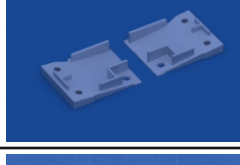
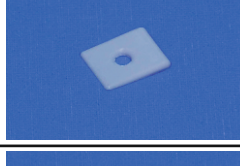
Kod Code Code Код	Kolor	Colour	Farbe	Цвет	
001	biały	white	weiss	белый	
111	srebrny	silver	silber	серебристый	
305	jasna sosna	light pine	kiefer-hell	светлая сосна	

Kod Code Code Код	Nazwa Name Bezeichnung Название	Kolor Colour Farbe Цвет	Pakowanie Packing Packen Упаковка	
B25-1004-111	Maskownica Dekolux srebrna; 2.65m, 5,8m Covering slat Dekolux silver; 2.65m, 5,8m Dekolux Blende silber; 2.65m, 5,8m Крышка маскирующая Dekolux серебристая; 2.65м, 5,8м	001, 111, 305	26,5/58 mb/lm/lm/m	
RN-0003-000	Rura aluminiowa, 25,0 x 0,7; 2.65m, 3m, 6m Aluminium tube 25,0x0,7; 2.65m, 3m, 6m Aluminiumrohr 25,0 x 0,7; 2.65lm, 3lm, 6lm Труба алюминиевая 25,0 x 0,7; 2.65м, 3м, 6м	000	26,5/30/60 mb/lm/lm/m	
RN-0007-000	Rura aluminiowa 26,3 x 1,15, 5.8m Aluminium tube 26,3x1,15, 5.8m Aluminiumrohr 26,3 x 1,15, 5.8m Труба алюминиевая 26,3 x 1,15, 5.8m	000	58 mb/lm/lm/m	
B26-2001-111	Prowadnica B26 srebrna, 5.8m Side guide B26 silver 5.8m Seitenführung B26 silber, 5.8m Направляющая B26 серебристая, 5.8м	001, 111, 305	58 mb/lm/lm/m	
B26-2033-111	Belka dolna B26 srebrna; 5,8 m Aluminium bottom bar B26 silver; 5,8 m Aluminium Unterleiste B26 silber; 5,8 m Планка нижняя алюминиевая B26 серебристая; 5,8м	001, 111, 305	58 mb/lm/lm/m	
B7-2003-111	Belka obciążająca aluminiowa srebrna; 2.65m, 5,8m Aluminium bottom bar silver; 2.65m, 5,8m Aluminium Unterleiste; silber, 2.65m, 5,8m Планка нижняя алюминиевая серебристая; 2.65м, 5,8м	001, 111, 305	26,5/58 mb/lm/lm/m	
B26-1209-111	Komplet części B26 do belki B26, szary PVC component set B26 for bottom bar with groove, grey B26 Komponenten Set / Endleiste B26, grau Комплект компонентов B26 для планки нижней B26, серый	001, 111, 305	25 kpl/set/kpl/ компл	
B26-1009-111	Komplet części B26 do belki B7, szary PVC component set B26 for bottom bar B7, grey B26 Komponenten Set / Endleiste B7, grau Комплект компонентов B26 для планки нижней B7, серый	001, 111, 305	25 kpl/set/kpl/ компл	
B25-2011-111	Szczotka przeciwkurzowa 4,8 x 13,0 Antidust brush 4,8 x 13,0 Antistaubbürste 4,8 x 13,0 Щётка 4,8 x 13,0	111	300 mb/lm/lm/m	
B25-2012-111	Szczotka przeciwkurzowa 4,8 x 9,0 Antidust brush 4,8 x 9,0 Antistaubbürste 4,8 x 9,0 Щётка 4,8 x 9,0	111	225 mb/lm/lm/m	

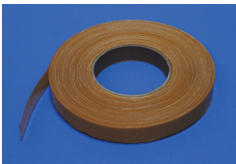
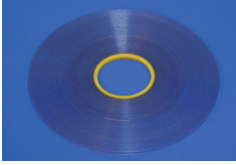
Kod Code Code Код	Nazwa Name Bezeichnung Название	Kolor Colour Farbe Цвет	Pakowanie Packing Packen Упаковка	
BW-0001-000	Blachowkręć 3,0x12 Screw 3,0x12 Schraube 3,0x12 Шуруп 3,0x12	000	1000 szt/pcs/st/шт	
BW-0002-000	Blachowkręć 3,0x16 Screw 3,0x16 Schraube 3,0x16 Шуруп 3,0x16	000	1000 szt/pcs/st/шт	
BW-0006-000	Blachowkręć 2,2 x 4,5 Screw 2,2x4,5 Schraube 2,2 x 4,5 Шуруп 2,2 x 4,5	000	2000 szt/pcs/st/шт	
B11-1012-001	Sprężyna S50 B11 biała Spring S50 B11 white Feder S50 B11 weiss Пружина s50 b11 белый	001, 111	25 szt/pcs/st/шт	
B21-1027-010	Kluczyk Key Schlüssel Ключик	010	1 szt/pcs/st/шт	
B26-1110-111	Kostka montażowa B26 10°, szara Mounting component B26 10°, grey B26 Montageelement 10°, grau Монтажный элемент B26, серый	001, 111, 305	25 kpl/set/kpl/ компл	
B26-1112-111	Podkładka pod kostkę montażową B26 12°, szara Washer 12° for B26 mounting component, grey B26 Montage-Unterplatte 12°, grau Подкладка 12° для монтажного элемента B26, серая	001, 111, 305	25 kpl/set/kpl/ компл	
B26-1190-111	Podkładka pod kostkę montażową B26 90°, szara Washer 90° for B26 mounting component, grey B26 Montage-Unterplatte 90°, grau Подкладка 90° для монтажного элемента B26, серая	001, 111, 305	25 kpl/set/kpl/ компл	
B25-2102-001	Klin korygujący 6° PVC spacer 6° Ausgleichwinkelkeil 6° Клин направляющий 6°	001	42 szt/pcs/st/шт	
B25-2103-001	Klin korygujący 4° PVC spacer 4° Ausgleichwinkelkeil 4° Клин направляющий 4°	001	42 szt/pcs/st/шт	

Kod Code Code Код	Nazwa Name Bezeichnung Название	Szerokość Width Breite Ширина	Pakowanie Packing Packen Упаковка	
DW-19-50	Taśma dwustronna wzmocniona Strengthened double-sided tape Doppelseitiges verstärktes Klebeband Лента двухсторонняя укреплённая	9, 12, 15, 19, 25, 38	1 szt/pcs/st/шт	
LM-07-100	Listwa mocująca z klejem Fastening belt with glue Befestigungsleiste mit Kleber Полоска для крепления с клеем	4, 6, 7, 8, 9, 16	1 szt/pcs/st/шт	
TF-19-50	Taśma dwustronna na flizelinie, Flizeline double-sides tape Doppelseitiges Klebeband, Лента двухсторонняя на флизелине	9, 12, 15, 19, 25	1 szt/pcs/st/шт	



BAMAR-POL SP. Z O.O.
Graniczna 2
45-587 Opole, Poland
VAT no. 754-04-03-981

PL OFFICE
Dworcowa 20
46-024 Jełowa, Poland
tel.: +48 774 270 110
handlowy@bamar.pl

EXPORT OFFICE
Dworcowa 20
46-024 Jełowa, Poland
tel.: +48 774 270 010
export@bamar.pl