

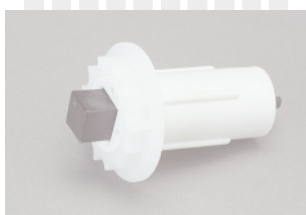

bamar.pl



BAMAR 36

B36

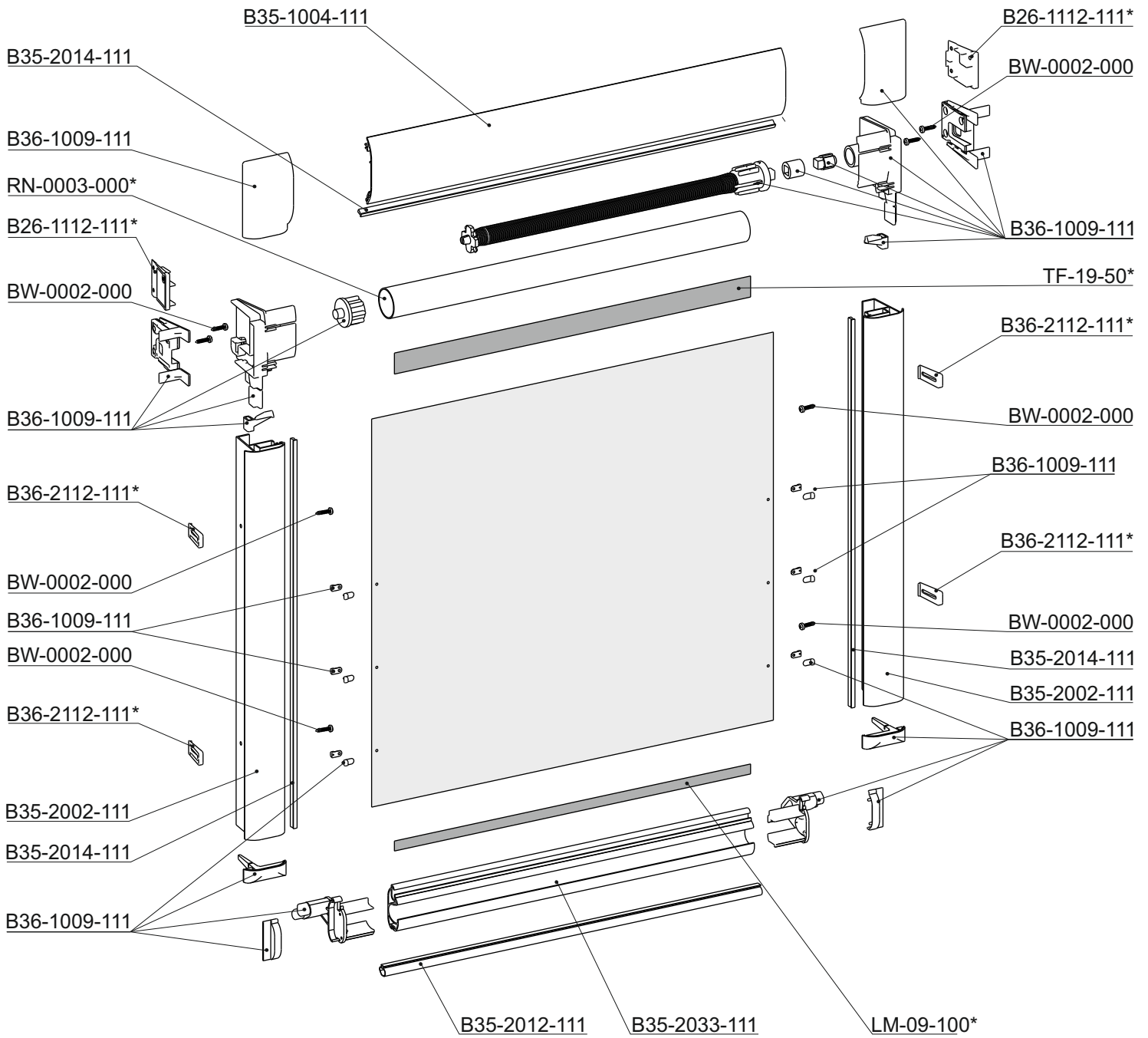





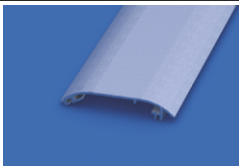
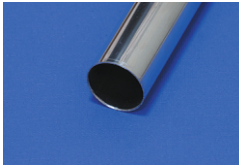
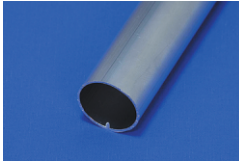
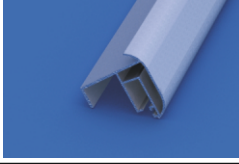
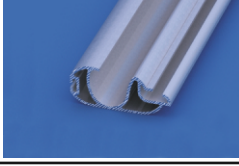
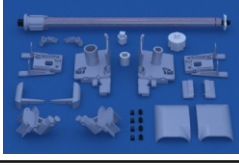
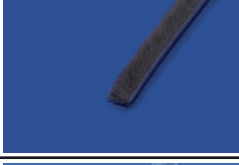
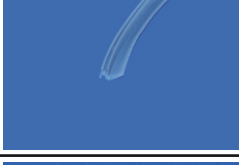
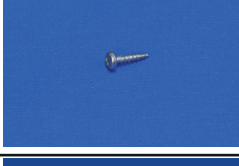
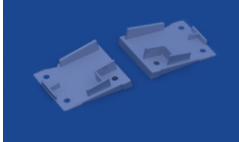

*	↻
RN-0003-000	RN-0007-000
B26-1112-111	B26-1190-111
B36-2112-001	B36-2190-001
TF-19-50	DW-19-50
LM-09-100	LM-08-100

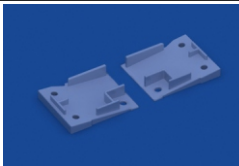
B36

Kod Code Code Код	Kolor	Colour	Farbe	Цвет	
111	srebrny	silver	silber	серебристый	

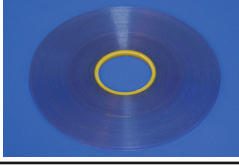
Kod Code Code Код	Nazwa Name Bezeichnung Название	Kolor Colour Farbe Цвет	Pakowanie Packing Packen Упаковка	
B35-1004-111	Maskownica B-35, 6m Covering slat B-35, 6m Blende B-35, 6lm Крышка маскирующая B-35, 6м	111	60 mb/lm/lm/m	
RN-0003-000	Rura aluminiowa, 25,0 x 0,7; 2.65m, 3m, 6m Aluminium tube 25,0x0,7; 2.65m, 3m, 6m Aluminiumrohr 25,0 x 0,7; 2.65lm, 3lm, 6lm Труба алюминиевая 25,0 x 0,7; 2.65м, 3м, 6м	000	26,5/30/60 mb/lm/lm/m	
RN-0007-000	Rura aluminiowa 26,3 x 1,15, 5.8m Aluminium tube 26,3x1,15, 5.8m Aluminiumrohr 26,3 x 1,15, 5.8lm Труба алюминиевая 26,3 x 1,15, 5.8m	000	58 mb/lm/lm/m	
B35-2002-111	Prowadnica B-35, 6m Side guide B-35, 6m Seitenführung B35, 6lm Направляющая B-35 алюминиевая, 6м	111	60 mb/lm/lm/m	
B35-2033-111	Belka obciążająca B35, 5.8m Alu bottom bar B35, 5.8m Unterleiste B35, 5.8lm Планка нижняя B-35 алюминиевая, 5.8m	111	58 mb/lm/lm/m	
B36-1009-111	Komplet części B36 B36 component set Komponentenset B36 Комплект компонентов B36	111	25 kpl/set/kpl/ компл	
B35-2014-111	Szczotka przeciwkurzowa 3,5x5 Brush 3,5x5 Antistaub Bürste 3,5x5 Щётка 3,5x5	111	650 mb/lm/lm/m	
B35-2012-111	Uszczelka B35, szara Seal B35 grey B35 Dichtung, grau Уплотнитель B35, серый	111	200 mb/lm/lm/m	
BW-0002-000	Blachowkręt 3,0x16 Screw 3,0x16 Schraube 3,0x16 Шуруп 3,0x16	000	1000 szt/pcs/st/шт	
B26-1112-111	Podkładka pod kostkę montażową B26 12°, szara Washer 12° for B26 mounting component, grey B26 Montage-Unterplatte 12°, grau Подкладка 12° для монтажного элемента B26, серая	111	25 kpl/set/kpl/ компл	

Kod Code Code Код	Nazwa Name Bezeichnung Название	Kolor Colour Farbe Цвет	Pakowanie Packing Packen Упаковка	
B26-1190-111	Podkładka pod kostkę montażową B26 90°, szara Washer 90° for B26 mounting component, grey B26 Montage-Unterplatte 90°, grau Подкладка 90° для монтажного элемента B26, серая	111	25 kpl/set/kpl/ компл	
B36-2112-111	Klin korygujący B36, 12°, szary PVC spacer 12° for B36, grey Ausgleichwinkelkeil 12°, grau Клин 12° B36, серый	111	150 szt/pcs/st/шт	
B36-2190-111	Klin korygujący B36, 90°, szary PVC spacer 90° for B36, grey Ausgleichwinkelkeil 90°, grau Клин 90° B36, серый	111	150 szt/pcs/st/шт	
DW-19-50	Taśma dwustronna wzmocniona Strengthened double-sided tape Doppelseitiges verstärktes Klebeband Лента двухсторонняя укреплённая	9, 12, 15, 19, 25, 38	1 szt/pcs/st/шт	
LM-09-100	Listwa mocująca z klejem Fastening belt with glue Befestigungsleiste mit Kleber Полоска для крепления с клеем	4, 6, 7, 8, 9, 16	1 szt/pcs/st/шт	
TF-19-50	Taśma dwustronna na flizelinie, Flizeline double-sides tape Doppelseitiges Klebeband, Лента двухсторонняя на флизелине	9, 12, 15, 19, 25	1 szt/pcs/st/шт	



BAMAR-POL SP. Z O.O.
Graniczna 2
45-587 Opole, Poland
VAT no. 754-04-03-981

PL OFFICE
Dworcowa 20
46-024 Jełowa, Poland
tel.: +48 774 270 110
handlowy@bamar.pl

EXPORT OFFICE
Dworcowa 20
46-024 Jełowa, Poland
tel.: +48 774 270 010
export@bamar.pl