

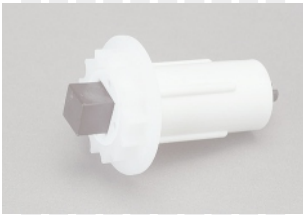

bamar.pl



BAMAR 49

B49

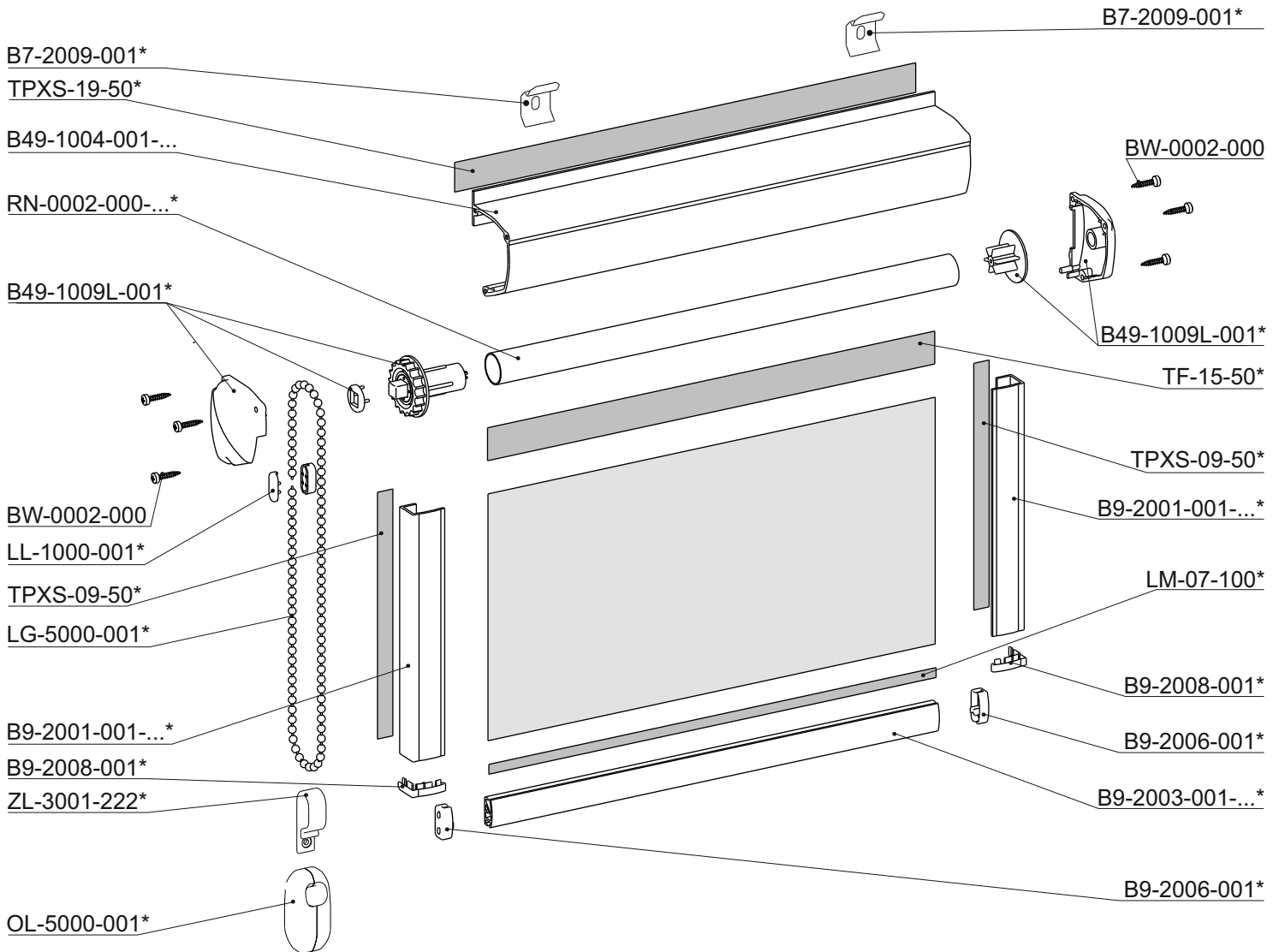

*



B9-2003-001-...
 B9-2001-001-...
 RN-0002-000-...
 B49-1009L-001
 LG-5000-001
 LL-1000-001
 B9-2008-001
 B9-2006-001
 B7-2019-001
 ZL-3001-222
 OL-5000-001
 TF-15-50
 TPXS-09-50
 TPXS-19-50
 LM-07-100

B7-2003-001-...
 B9-2002-001-..., B9-1001-001-..., B9-1002-001-...
 RN-0006-000-...
 B49-1009P-001
 LG-5000-001-P+LL-1000-222, LP-5000-001-..., LP-5000-001-...-P
 LL-5000-001
 B9-2018-001
 B7-2006-001, B7-2007-001
 B7-2009-001
 ZL-3000-222
 OL-1000-001
 DW-15-50
 TPXS-09-50-003
 TPXS-19-50-003
 LM-06-100

B49

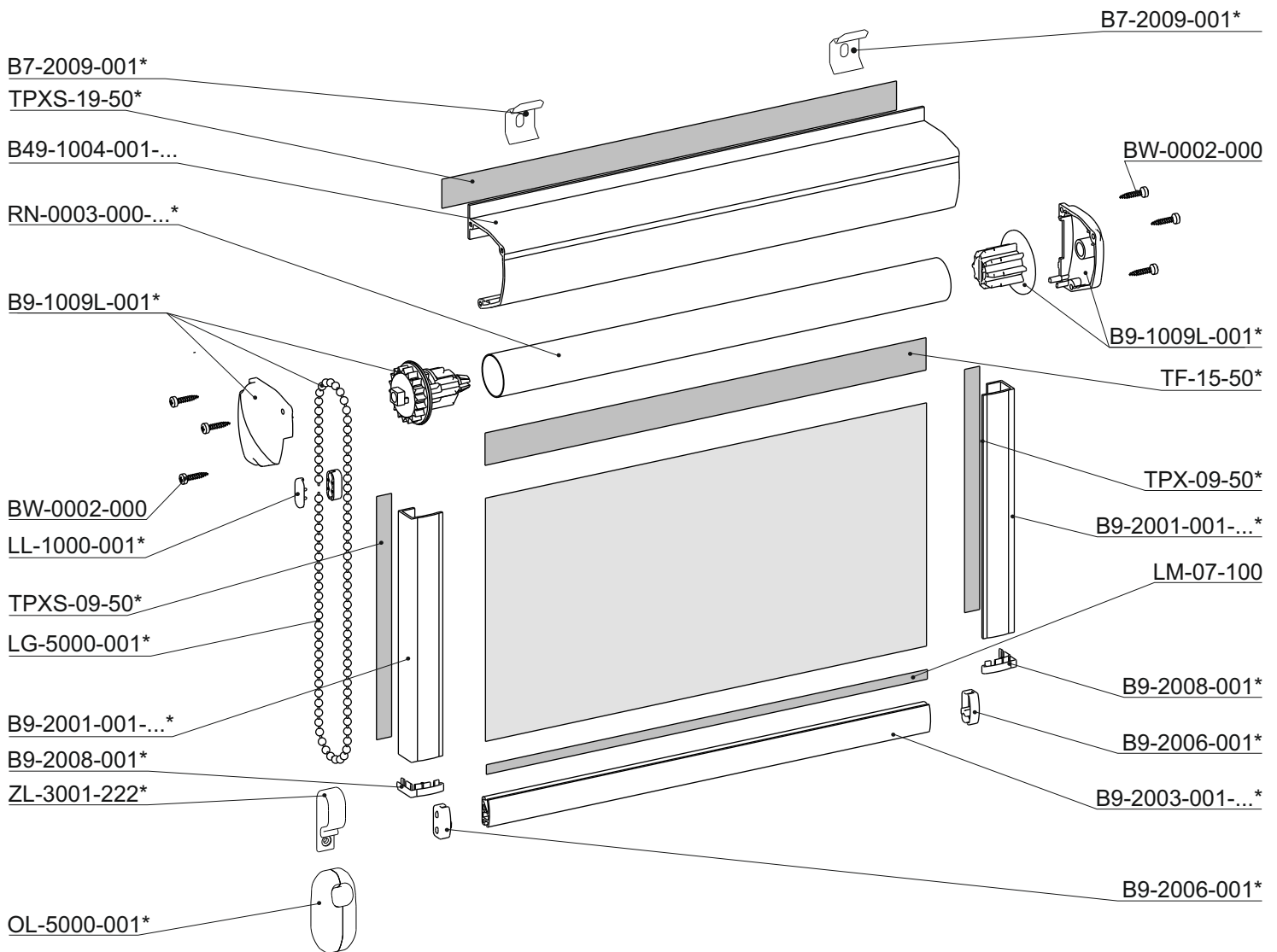

*



B9-2003-001-...	B7-2003-001-...
B9-2001-001-...	B9-2002-001-..., B9-1001-001-..., B9-1002-001-..., B9-2012-001
RN-0003-000-...	RN-0007-000-...
B9-1009L-001	B9-1009P-001
LG-5000-001	LG-5000-001-P+LL-1000-222, LP-5000-001-..., LP-5000-001-...-P
LL-1000-001	LL-5000-001
B9-2008-001	B9-2018-001
B9-2006-001	B7-2006-001, B7-2007-001
B7-2009-001	B7-2019-001
ZL-3001-222	ZL-3000-222
OL-5000-001	OL-1000-001
TF-15-50	DW-15-50
TPX-09-50	TPX-09-50-003
TPX-19-50	TPX-19-50-003
LM-07-100	LM-06-100

B49

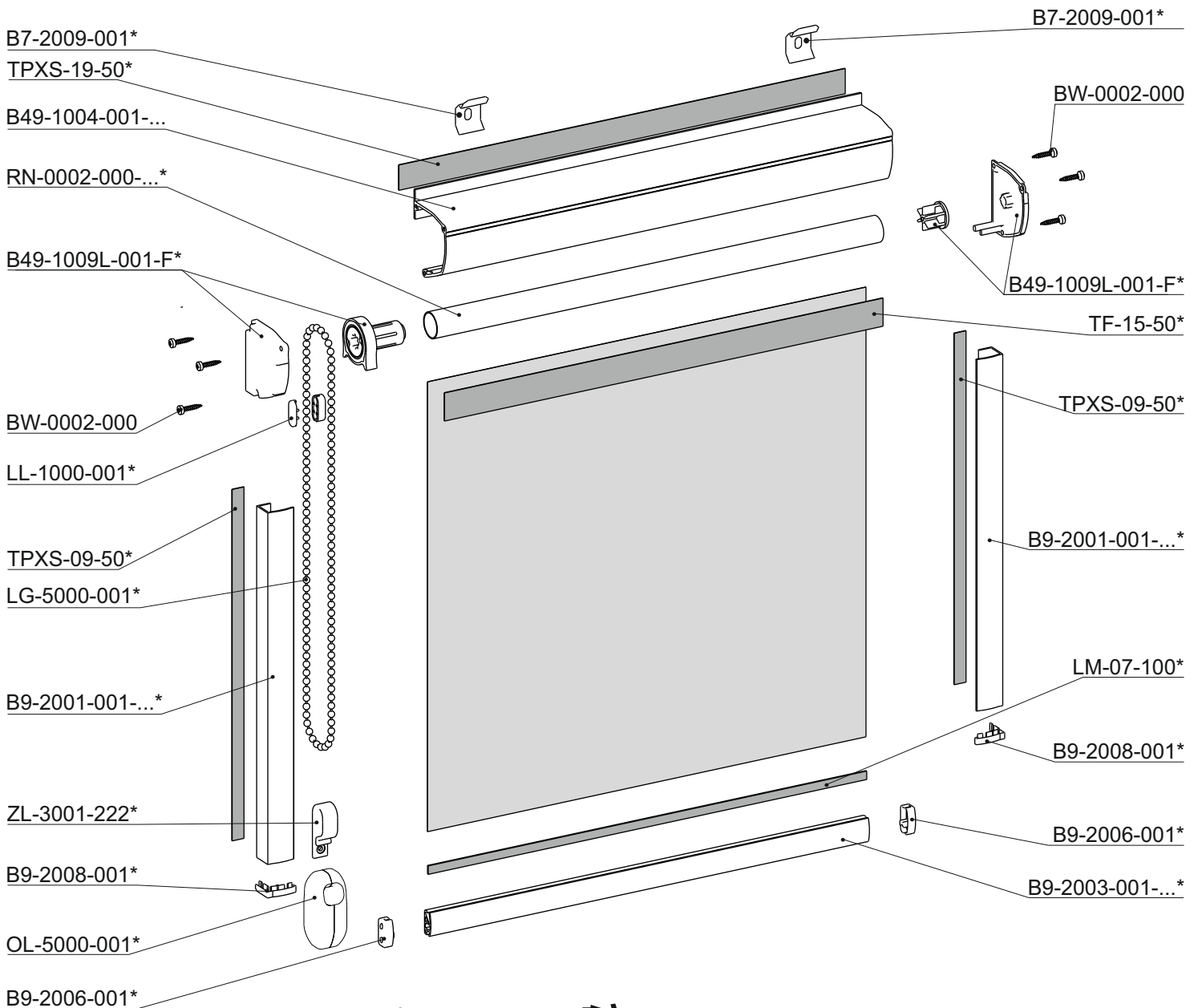

*



B9-2003-001-...
 B9-2001-001-...
 RN-0002-000-...
 B49-1009L-001-F
 LG-5000-001
 LL-1000-001
 B9-2008-001
 B9-2006-001
 B7-2009-001
 ZL-3001-222
 OL-5000-001
 TF-15-50
 TPXS-09-50
 TPX-19-50
 LM-07-100

B7-2003-001-...
 B9-2002-001-..., B9-1001-001-..., B9-1002-001-..., B9-2012-001
 RN-0006-000-...
 B49-1009P-001-F
 LG-5000-001-P+LL-1000-222, LP-5000-001-..., LP-5000-001-...-P
 LL-5000-001
 B9-2018-001
 B7-2006-001, B7-2007-001
 B7-2019-001
 ZL-3000-222
 OL-1000-001
 DW-15-50
 TPXS-09-50-003
 TPX-19-50-003
 LM-06-100

B49 D&N Roman

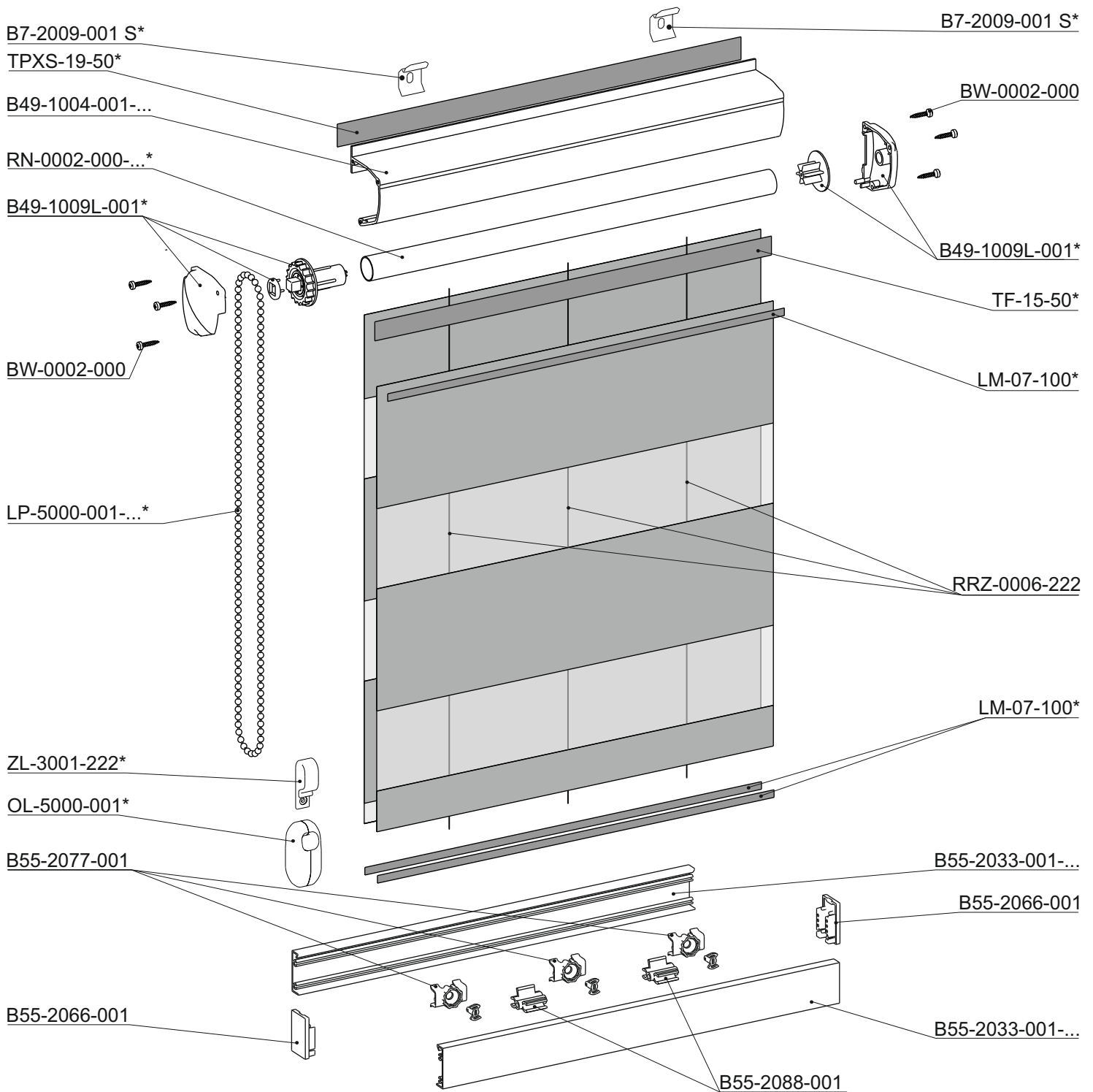







*





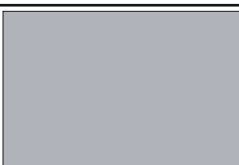
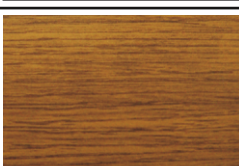

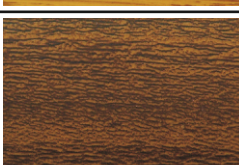
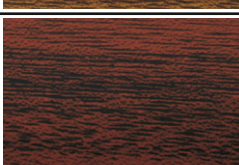

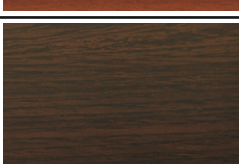

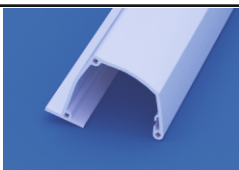
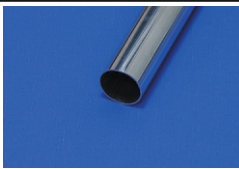
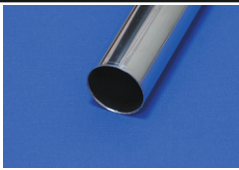
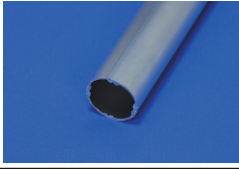
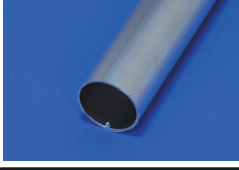
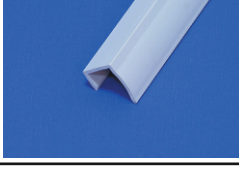
RN-0002-000-...
 B49-1009L-001
 LP-5000-001-...
 B7-2009-001
 ZL-3001-222
 OL-5000-001
 TF-15-50
 TPXS-19-50
 LM-07-100

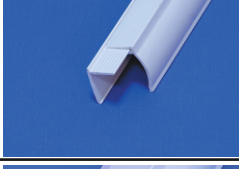
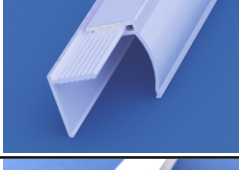
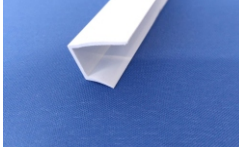



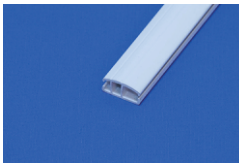

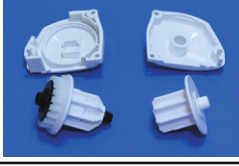
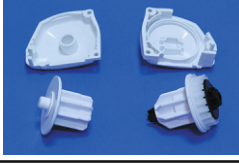

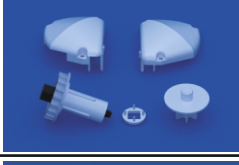
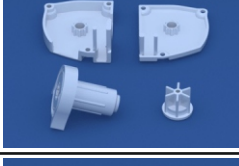
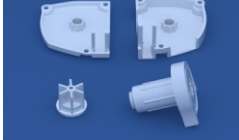

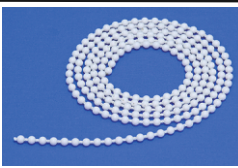
RN-0006-000-...
 B49-1009P-001
 LP-5000-001-..., LP-5000-001-...-P
 B7-2019-001
 ZL-3000-222
 OL-1000-001
 DW-15-50
 TPXS-19-50-003
 LM-06-100



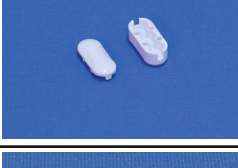



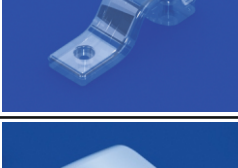

B49



Kod Code Code Код	Kolor	Colour	Farbe	Цвет	
001	biały	white	weiss	белый	
003	antracyt	anthracite	anthrazit	антрацит	
011	brązowy	brown	braun	коричневый	
111	srebrny	silver	silber	серебристый	
408	dąb złoty	gold oak	eiche-gold	золотой дуб	
409	jasny dąb	light oak	eiche-hell	светлый дуб	
410	orzech	nut brown	nuss	орех	
411	mahoń	mahogany	mahagoni	махагон	
412	wisnia	cherry red	kirsche	вишня	
413	orzech wenge	wenge nut	nuss-wenge	венге	

Kod Code Code Код	Nazwa Name Bezeichnung Название	Kolor Colour Farbe Цвет	Pakowanie Packing Packen Упаковка	
B49-1004-001	Kaseta PCV B49, biała, 2,65m; 5,8m; 6m PVC cassette B49 white, 2,65m; 5,8m; 6m PVC-Kassette B-49 Weiss, 2,65m; 5,8m; 6m Кассета ПВХ B49, белая, 2,65м; 5,8м; 6м	001, 003, 011, 111, 408, 409, 410, 411, 412, 413	26,5/58/60 mb/lm/lm/m	
RN-0002-000	Rura aluminiowa 18,0 x 0,65; 2.65m, 3m, 6m Aluminium tube 18,0x0,65; 2.65m, 3m, 6m Aluminiumrohr 18,0 x 0,65; 2.65lm, 3m, 6m Труба алюминиевая 18,0 x 0,65; 2.65м, 3м, 6м	000	26,5/30/60 mb/lm/lm/m	
RN-0003-000	Rura aluminiowa, 25,0 x 0,7; 2.65m, 3m, 6m Aluminium tube 25,0x0,7; 2.65m, 3m, 6m Aluminiumrohr 25,0 x 0,7; 2.65lm, 3lm, 6lm Труба алюминиевая 25,0 x 0,7; 2.65м, 3м, 6м	000	26,5/30/60 mb/lm/lm/m	
RN-0006-000	Rura aluminiowa ożebrowana 19,0 x 1,1, 5,8m Aluminium tube strengthened 19,0x1,1, 5,8m Aluminiumrippenrohr 19,0 x 1,1, 5,8m Труба алюминиевая укрепленная 19,0 x 1,1, 5,8м	000	58 mb/lm/lm/m	
RN-0007-000	Rura aluminiowa 26,3 x 1,15, 5,8m Aluminium tube 26,3x1,15, 5,8m Aluminiumrohr 26,3 x 1,15, 5,8m Труба алюминиевая 26,3 x 1,15, 5,8м	000	58 mb/lm/lm/m	
B9-2001-001	Prowadnica B9 9mm, dł. 2,65m; 6m PVC side guide B9 9 mm, 2,65m; 6m PVC Seitenführung B9 9 mm, 2,65m; 6m Направляющая B9 ПВХ 9мм, 2,65м; 6м	001, 003, 011, 408, 409, 410, 411, 412, 413	106/240 mb/lm/lm/m	
B9-2002-001	Prowadnica B9 18mm, 2,65m; 6m PVC side guide B9 18 mm, 2,65m; 6m PVC Seitenführung B9 18 mm, 2,65m; 6m Направляющая B9 ПВХ 18мм, 2,65м; 6м	001, 003, 011, 111, 408, 409, 410, 411, 412, 413	106/240 mb/lm/lm/m	
B9-1001-001	Prowadnica B9 składana, 2,65m PVC side guide-folding B9, 2,65m Trennbare PVC Seitenführung B9, 2,65m Направляющая B-9 составная, 2,65м	001	53 mb/lm/lm/m	
B9-1002-001	Prowadnica B9 składana szeroka, 2,65m Folding PVC side guide B9 wide, 2,65m Trennbare B9 PVC Seitenführung breit, 2,65m Направляющая B9 ПВХ составная широкая, 2,65м	001	53 mb/lm/lm/m	
B9-2012-001	Prowadnica B9 z zaokrągloną stopką 2,65m PVC side guide B9 with rounded base 2,65m PVC Seitenführung B9 mit abgerundetem Fuß 2,65m Боковая направляющая из ПВХ B9 с закругленной ножкой 2,65 м	001	106 mb/lm/lm/m	

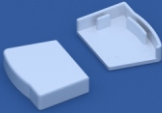
Kod Code Code Код	Nazwa Name Bezeichnung Название	Kolor Colour Farbe Цвет	Pakowanie Packing Packen Упаковка	
B7-2003-001	Belka obciążająca aluminiowa biała, 2.65m, 5,8m, 6m Aluminium bottom bar white, 2.65m, 5,8m, 6m Aluminium Unterleiste, 2.65m, 5,8m, 6m Планка нижняя алюминиевая белая, 2.65м, 5,8м, 6м	001, 002, 003, 111, 308, 309, 310, 311, 312, 313	26,5/58/60 mb/lm/lm/m	
B9-2003-001	Belka obciążająca PCV, 2.65m PVC bottom bar, 2,65m PVC Unterleiste, 18 mm, 2,65m Планка нижняя ПВХ белая, 2,65м	001, 003, 011, 111, 408, 409, 410, 411, 412, 413	53 mb/lm/lm/m	
B39-2003-001	Pręt obciążający, biały, 2.65m, 4m Alu Tiltrod weight white, 2.65m, 4m Alu-Beschwerdestab- Weiss, 2.65m, 4m Прут-утяжелитель алюминиевый, белый, 2.65м, 4м	001, 002, 003, 501, 505	20/26,5 mb/lm/lm/m	
B55-2033-001	Belka obciążająca rolety rzymskiej biała, 5.8m Bottom bar for roman blind, white, 5.8m Die Unterleiste zum Raffrollo, weiss, 5.8m Нижняя планка для римских штор, белая 5.8м	001, 003, 010, 111	116 mb/lm/lm/m	
B9-1009L-001	Komplet części B9 lewy (Ø25 mm), biały Chain mechanism B9 left (Ø25 mm), white Antrieb B9 links (Ø25 mm), weiss Механизм управления B9 левый (Ø25 mm), белый	001, 003, 011, 111, 408, 409, 410, 411, 412, 413	25 kpl/set/kpl/ компл	
B9-1009P-001	Komplet części B9 prawy (Ø25 mm), biały Chain mechanism B9 right (Ø25 mm), white Antrieb B9 rechts (Ø25 mm), weiss Механизм управления B9 правый (Ø25 mm), белый	001, 003, 011, 111, 408, 409, 410, 411, 412, 413	25 kpl/set/kpl/ компл	
B49-1009L-001	Komplet części B49 lewy (Ø18 mm), biały Chain mechanism B49 left (Ø18 mm), white Antrieb B49 links (Ø18 mm), weiss Механизм управления B49 левый (Ø18 mm), белый	001, 003, 011, 111, 408, 409, 410, 411, 412, 413	25 kpl/set/kpl/ компл	
B49-1009P-001	Komplet części B49 prawy (Ø18 mm), biały Chain mechanism B49 right (Ø18 mm), white Antrieb B49 rechts (Ø18 mm), weiss Механизм управления B49 правый (Ø18 mm), белый	001, 003, 011, 111, 408, 409, 410, 411, 412, 413	25 kpl/set/kpl/ компл	
B49-1009L-001-F	Komplet części B49 lewy płaski, biały Chain mechanism B49 flat left, white Antrieb B49 flach links, weiss Механизм управления B49 плоский левый белый	001, 003, 011, 408, 409, 410, 411, 412, 413	25 kpl/set/kpl/ компл	
B49-1009P-001-F	Komplet części B49 prawy płaski, biały Chain mechanism B49 flat right, white Antrieb B49 flach rechts, weiss Механизм управления B49 плоский правый белый	001, 003, 011, 408, 409, 410, 411, 412, 413	25 kpl/set/kpl/ компл	

Kod Code Code Код	Nazwa Name Bezeichnung Название	Kolor Colour Farbe Цвет	Pakowanie Packen Packen Упаковка	
LG-5000-001	Łańcuszek kulkowy Ø4,5mm, biały Ball chain Ø4,5mm, white Perlenkette Ø4,5mm, weiss Цепочка шариковая Ø4,5mm, прозрачная	001, 003, 011, 111, 408, 411	250 mb/lm/lm/m	
LG-5000-001-P	Łańcuszek kulkowy Ø4,45mm, przezroczysty Ball chain Ø4,45mm transparent Perlenkette Ø4,45 mm, transparent Цепочка шариковая Ø4,45mm, прозрачная	001, 011, 111	250 mb/lm/lm/m	
LP-5000-001-...	Łańcuszek pętla 1; 1.5; 2; 2.5; 3; 3.5; 4m Chain loop 1; 1.5; 2; 2.5; 3; 3.5; 4m Endlosekette 1; 1.5; 2; 2.5; 3; 3.5; 4 lm Цепочка-петля 1; 1.5; 2; 2.5; 3; 3.5; 4м	001, 003, 011, 111, 114, 408, 411	10 szt/pcs/st/шт	
LP-5000-001-...-P	Łańcuszek pętla 1; 1.5; 2; 2.5; 3; 3.5; 4m transparentny Chain loop 1; 1.5; 2; 2.5; 3; 3.5; 4m transparent Endlosekette 1; 1.5; 2; 2.5; 3; 3.5; 4lm, Transparent Цепочка-петля, 1; 1.5; 2; 2.5; 3; 3.5; 4м прозрачная	001, 011	10 szt/pcs/st/шт	
LL-1000-001	Łącznik łańcuszka, biały Connection clip, white Kugelnkettenverbinder, weiss Соединитель цепочки, белый	001, 011, 111, 222, 414	100 szt/pcs/st/шт	
LL-5000-001	Łącznik łańcuszka, biały Connection clip, white Kugelnkettenverbinder, weiss Соединитель цепочки, белый	001, 010, 011, 111, 114, 408, 411	100 szt/pcs/st/шт	
UL-1000-001	Uchwyt łańcuszka, biały Chain handle, white Kettengriff, weiss Крепитель цепочки, белый	001, 011	125 szt/pcs/st/шт	
ZL-3001-222	Uchwyt zabezpieczający łańcuszka mały, bezbarwny Safety handle for chain, transparent Sicherheitsgriff für die Kette, farblos Малый фиксатор цепочки, прозрачный	222	100 szt/pcs/st/шт	
ZL-3000-222	Uchwyt zabezpieczający łańcuszka, bezbarwny Safety handle for chain, transparent Sicherheitsgriff für die Kette, farblos Фиксатор цепочки, прозрачный	222	100 szt/pcs/st/шт	
OL-1000-001	Obciążnik łańcuszka, biały Ball chain weight, white Kettenbeschwerer, weiss Грузик цепочки, белый	001, 003, 011, 111	200 szt/pcs/st/шт	

Kod Code Code Код	Nazwa Name Bezeichnung Название	Kolor Colour Farbe Цвет	Pakowanie Packing Packen Упаковка	
OL-5000-001	Obciążnik łańcuszka, biały Ball chain weight, white Kettenbeschwerer, weiss Грузик цепочки, белый	001, 003, 011, 111, 411	100 szt/pcs/st/шт	
OL-5010-111	Balast obciążnika łańcuszka Ballast chain weight Ballast für Kettenbeschwerer Балласт грузика цепочки	111	100 szt/pcs/st/шт	
B7-2006-001	Zaślepka belki obciążającej, biała End cap, white Endleiste Blendestopfen, weiss Заглушка нижней планки, белая	001, 002, 003, 111	125 kpl/set/kpl/ компл	
B7-2007-001	Zaślepka belki obciążającej płaska, biała End cap flat, white Endleiste Blendestopfen, weiss Заглушка нижней планки, белая	001, 002, 003, 111	125 kpl/set/kpl/ компл	
B9-2006-001	Zaślepka belki obciążającej, biała End cap, white Endleiste Blendestopfen, weiss Заглушка нижней планки, белая	001, 003, 011, 111	125 kpl/set/kpl/ компл	
B55-2066-001	Zaślepka belki obciążającej rolety rzymskiej D&N biała End cap for bottom bar for roman blind, white Endkappe der Unterleiste zum Raffrollo, weiss Заглушка нижней планки для римских штор, белая	001, 003, 111	50 szt/pcs/st/шт	
B9-2008-001	Zaślepka prowadnicy B9, biała Side guide end cap, white Endkappe für Seitenführung, weiss Заглушка направляющей, белая	001, 003, 011, 111, 308, 310, 311, 312	125 kpl/set/kpl/ компл	
B9-2018-001	Zaślepka prowadnicy B9 pełna, biała End cap for side guide B9, white Endkappe für Seitenführung, weiss Заглушка направляющей B9, белая	001, 003, 011, 111, 308, 309, 310, 311, 312, 313	125 kpl/set/kpl/ компл	
BW-0002-000	Blachowkręt 3,0x16 Screw 3,0x16 Schraube 3,0x16 Шуруп 3,0x16	000, 010, 502	1000 szt/pcs/st/шт	
B7-2009-001	Klip kasety B7 Biały Cassette clip B7 white Montage Clip B7 weiss Клип кассеты B7 белый	001, 002	100 szt/pcs/st/шт	

Kod Code Code Код	Nazwa Name Bezeichnung Название	Kolor Colour Farbe Цвет	Pakowanie Packing Packen Упаковка	
B7-2019-001	Klip naścienny kasety B7, biały Wall clip for cassette B7 white Montage-Clip B-7 Weiss Клип настенный кассеты B7	001, 002	100 szt/pcs/st/шт	
B9-1017-001	B9 krążek prowadzący, biały Disc B9, white B9 Führungsscheibe, weiss Диск B9, белый	001	100 szt/pcs/st/шт	
B55-2077-001	Napinacz żyłki belki obciążającej rolety rzymskiej D&N Bottom bar line tensioner for roman blind Saitenspanner der Unterleiste zum Raffrollo Натяжитель лески нижней планки для римских штор	001	100 szt/pcs/st/шт	
B55-2088-001	Łącznik profili belki obciążającej rolety rzymskiej D&N Bottom bar profile connector for roman blind Profilverbindung der Unterleiste zum Raffrollo Соединитель профилей нижней планки для римских штор	001	100 szt/pcs/st/шт	
RRZ-0006-222	Plecionka 0,06 mm bezbarwna, 500m Technical vein 0,06 mm transparent, 500m Geflochtene Nylon-Schnur, 500m Леска техническая 0,06мм, 500м	222	1 szt/pcs/st/шт	
DW-15-50	Taśma dwustronna wzmocniona Strengthened double-sided tape Doppelseitiges verstärktes Klebeband Лента двухсторонняя укрепленная	9, 12, 15, 19, 25, 38	1 szt/pcs/st/шт	
TPXS-15-50	Taśma piankowa solwentowa Foam tape solvent Schaumklebeband Lösungsmittel Лента пенковая растворитель	9,12,15,19	1 szt/pcs/st/шт	
TPXS-15-50-003	Taśma piankowa solwentowa antracyt Foam tape solvent anthracite Lösungsmittel-Schaumklebeband Anthrazit лента для вспененного растворителя антрацит	9, 15, 19	1 szt/pcs/st/шт	
LM-07-100	Listwa mocująca z klejem Fastening belt with glue Befestigungsleiste mit Kleber Полоска для крепления с клеем	4, 6, 7, 8, 9, 16	1 szt/pcs/st/шт	
TF-15-50	Taśma dwustronna na flizelinie, Flizeline double-sides tape Doppelseitiges Klebeband, Лента двухсторонняя на флизелине	9, 12, 15, 19, 25	1 szt/pcs/st/шт	



BAMAR-POL SP. Z O.O.
Graniczna 2
45-587 Opole, Poland
VAT no. 754-04-03-981

PL OFFICE
Dworcowa 20
46-024 Jełowa, Poland
tel.: +48 774 270 110
handlowy@bamar.pl

EXPORT OFFICE
Dworcowa 20
46-024 Jełowa, Poland
tel.: +48 774 270 010
export@bamar.pl